

Aqu@Fan II

Fan Coil Units

New : Available with EC motor

AWC, AWN, AHC, AHN Models



Quality, efficiency and reliability, built into every unit...



Support feet supplied as optional

Vertical console units with cabinet, AWC type

AWC vertical console units are designed for use in three different types of installation :

- as a wall hung console in areas where a skirting board prevents the use of a floor mounted console ;
- as a floor console with optional front air intake RF (most frequently located below a large window) ;
- as a floor console with support feet and bottom air intake.

They feature a modern decorative style cabinet with matching plastic discharge grille, providing a high performance unit that is attractive and durable which will complement any room decor.

The AWC models can be fitted, as optional, with electromechanical or electronic Aqu@Net control, with valve kits, etc.

Vertical concealed units without cabinet, AWN type

AWN vertical chassis only units are designed for applications that require a fully concealed or a fully recessed installation.

These units include all the features of the AWC vertical console unit type except that only the chassis is supplied instead of decorative style cabinet.

Like the AWC units, Aqu@Net control (except the remote control) as well as other electromechanical controls and valve kits can be fitted, as optional, on unit.

Units can be fitted with optional feet (supplied loose), if floor mounting is required.



Bottom air intake grille supplied as optional

Ceiling exposed units with cabinet, AHC type

AHC ceiling exposed units are designed for ceiling mounting in areas where it is necessary to conserve floor space.

They contain all the features of the AWC unit within the decorative style cabinet with matching plastic discharge grille.

Standard version is designed for rear horizontal air intake without inlet grille.

Similar to the previous models, the Aqu@Net control can be supplied, as optional, on AHC units with remote control. Other optional controls and valve kits are also available.

Ceiling concealed units without cabinet, AHN type

AHN ceiling chassis units are designed for concealed or recessed ceiling installations. This unit consists of the AHC basic unit horizontally installed.

AHN units contain all the features of the AHC ceiling exposed units except that only the chassis casing is supplied instead of the decorative style cabinet.

Possibility of supplying separately an optional Aqu@Net type remote control for wall mounting. Other optional controls and valve kits are also available.



Auxiliary drain pan supplied as optional

New range of fan coil units Aqu@Fan II : "Innovation for an optimum comfort"

Easy to install, improvement in sound levels and performances, Aqu@Net electronic control...

The range of **Aqu@Fan II** fan coil units is issued from a development striving to meet customers' wishes and advices.

Aesthetic of the grille, associated with the casing refined finish allows a harmonious and smart integration of the fan coil units **Aqu@Fan II** in all types of interiors.

They are the ideal solution to air condition agreeably and efficiently, flats, hotels, hospitals, offices and other premises, all year long.

The Aqu@Fan II fan coil units range includes **9 sizes** with air flows ranging from **100 thru 1600 m³/h**, for cooling capacities of **1 thru 10 kW**.

The Aqu@Fan II fan coil units are equipped with optimized coils to bring the best possible performances in **2-pipe, 4-pipe, or 2-pipe/2-wire versions**.

Moreover, the new technology of the fan motor assembly, through the use of optimized centrifugal impellers, associated with a **5-speed motor enables all Aqu@Fan II models to reach an average decrease in sound levels of - 4dB**A, compared with the previous range, offering therefore a maximum acoustical comfort.

Aqu@Fan II range is provided with an **electronic control : Aqu@Net**, whose ergonomic and discrete remote command can be loose or fitted on the fan coil unit.

All settings being made at factory, no needs to be done by installer.

This control, especially innovating, **offers as standard a master/slave function up to 15 units** from one single remote control.

Other features like window contact, occupied/unoccupied, antifreeze modes are integrated without involving any price add.

Design features

Cabinet

All units are manufactured from heavy-gauge zinc coated sheet steel for long life and durability. Oven baked powder epoxy paint insures a good protection and an attractive finish for all outside panels (Standard colour : **RAL 9003**).

The standard discharge grille is made of "ABS" plastic and has a different colour from the cabinet (standard colour : **Pantone 427C**).

On the versions with optional front intake, monobloc grille, painted in RAL 9003, is mounted flush to the cabinet. Grille can be removed by releasing the two quarter turn fixing screws to get access to the filter.

Casing

Made of galvanized steel insulated with closed cell polyethylene foam. Casing has 4 slotted lugs on its rear side which allow the unit to be easily and quickly installed at site, in wall or ceiling mounting.

Access to all internal components of the unit is facilitated by an easy dismounting of the casing.

Condensate drain pan is fabricated from galvanized sheet steel coated with closed cell polyethylene foam on external face. **The drain pan is painted to insure the anticorrosion protection.**

All models are equipped with an inclined condensate drain pan to ensure optimal condensate draining and to minimize water retention.

Moreover, models 20 to 70 are also equipped with a **V-shape pan in order to allow either vertical or horizontal installation.**

Coils

Made of staggered copper tubes, mechanically expanded into high efficiency hydrophilic aluminium fins, assuring maximum heat transfer efficiency.

Each fan coil unit is equipped with a 2 or 3-row cooling coil plus 1 row optional heating coil.

On models 10, 80 and 90, the 4-pipe and 2-pipe/2-wire coils are supplied in one finned block. On models 20 to 70, the 4-pipe and 2-pipe/2-wire coils are additional to the 2-pipe coil.

Each coil is supplied with headers having air vent at the highest point and drain plug at the lowest point. The water connection of each header is 1/2" gas female threaded type.

For the 2-pipe/2-wire systems, the electric heating coil is composed of heating **rod type resistances** mounted inside the coil (at the place of hot water tubes).

Note : The water connection side is defined left-hand or right-hand when observer is looking at the unit from the discharge side.

Fan and motor assembly

The units are fitted with a fan-motor assembly of which the fan is composed of double inlet forward curved centrifugal wheel(s) dynamically balanced and specially designed for an optimal air flow and a low noise level.

The Aqu@Fan II range can be supplied with 2 types of motor :

- The **standard AC motor of asynchrone direct drive type** having 5 speeds, 3 of them are factory pre-wired, equipped with a built-in normally closed thermal protection of automatic reset type.
- The **EC motor** of high efficiency and low electrical consumption type for a significant energy saving. The motor is suitable for 0-10 V input, ensuring variable speed capability. It is fitted with ECospeed3 interface card (supplied as standard) for a 3-speed optimized running. Available on sizes 20-30-40-50-60.

Power supply : 230 V ± 10%/1 Ph/50 Hz - 60 Hz (50 Hz on size 70).

Electrical connections

Units are supplied complete with internal electrical wiring terminating in a junction block protected by a cap or the cabinet.

Cabinet internal space allows installation of optional control systems supplied by manufacturer or others.

When the optional Aqu@Net control is fitted on the unit, the controller includes a junction block for power supply connection and incorporates, as standard, a cable clamp.

Filter

Easily removable cleanable filter having fire class M1 and G2 efficiency. Filter media is mounted on a metallic frame.

Options

Many different options and accessories are available for all units : see chapter "Mounting accessories". Controls are shown in the corresponding chapter.

Models designation

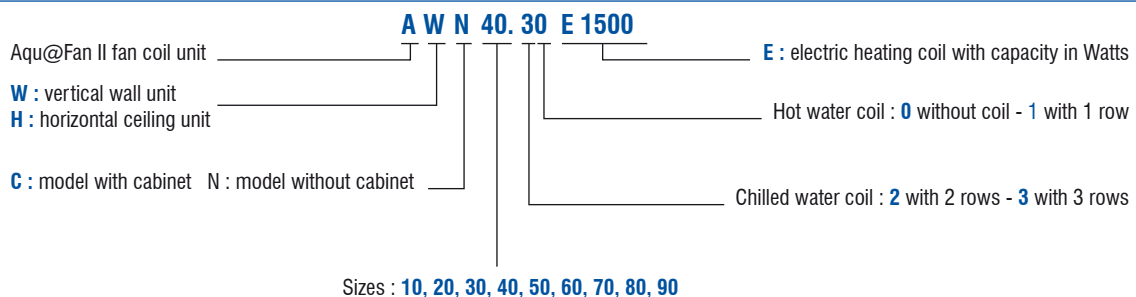

Advantages of Aqu@Fan II with EC motor

Energy class

More efficient

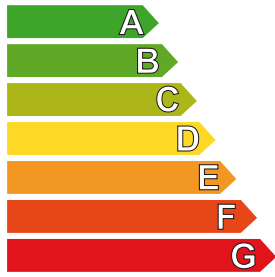

Less efficient

Models	Size 20			
	2020	2021	2030	2031
FCEER	B	B	B	B
FCCOP	B	B	B	B
Models	Size 30			
	3020	3021	3030	3031
FCEER	C	C	B	C
FCCOP	C	B	C	B
Models	Size 40			
	4020	4021	4030	4031
FCEER	A	A	A	A
FCCOP	A	A	A	A
Models	Size 50			
	5020	5021	5030	5031
FCEER	A	A	A	A
FCCOP	A	A	A	A
Models	Size 60			
	6020	6021	6030	6031
FCEER	B	B	B	B
FCCOP	B	B	B	B

Electrical consumption with EC motor (in Watts) → Energy savings

Models	Size 20	Size 30	Size 40	Size 50	Size 60
V1	26.8	33	35	45.5	71.8
V2	19.3	25.5	23	21.7	44.3
V3	11.8	20.5	15	19.2	30.5
V4	9.3	16.8	13	10.5	24.3
V5	5.5	10.4	6.8	7.8	18

Without control consumption, static pressure 0 Pa.

3-speed control interface for EC motor

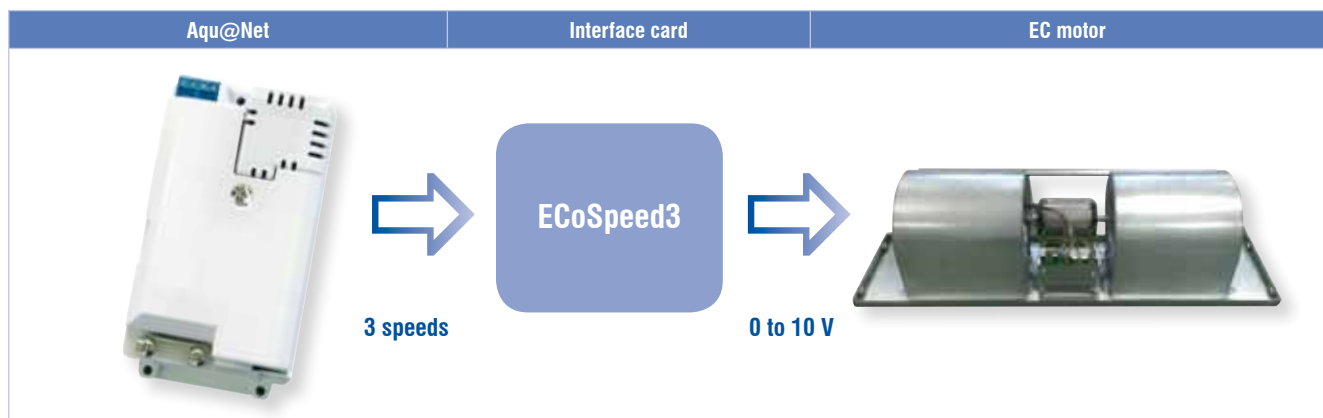

EC and AC motor absorbed power comparison

Aqu@Fan II size 20

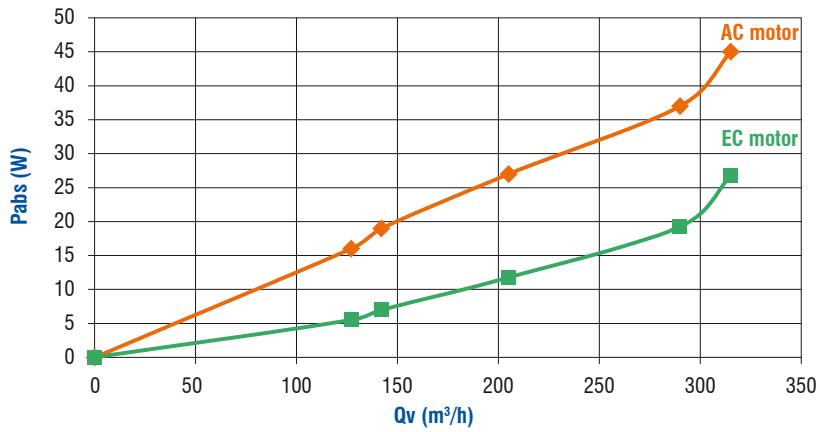

Aqu@Fan II size 30

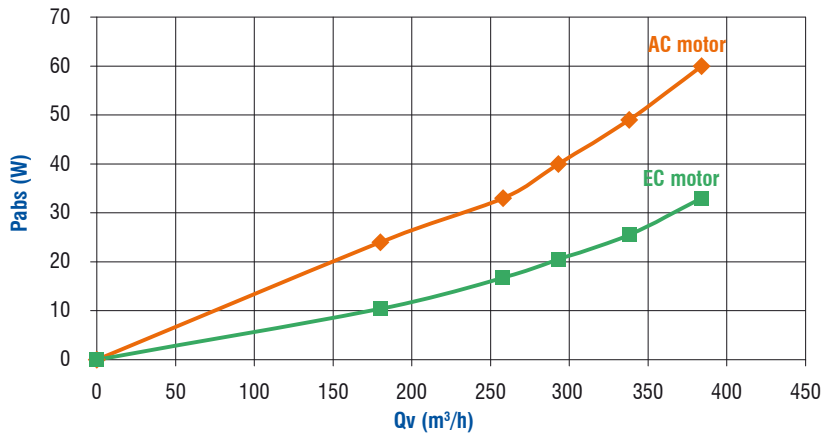

Aqu@Fan II size 40

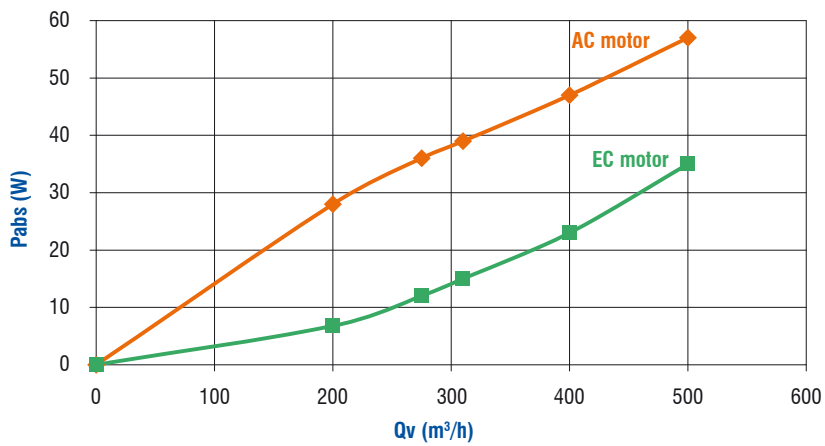

EC and AC motor absorbed power comparison (continued)

Aqu@Fan II size 50

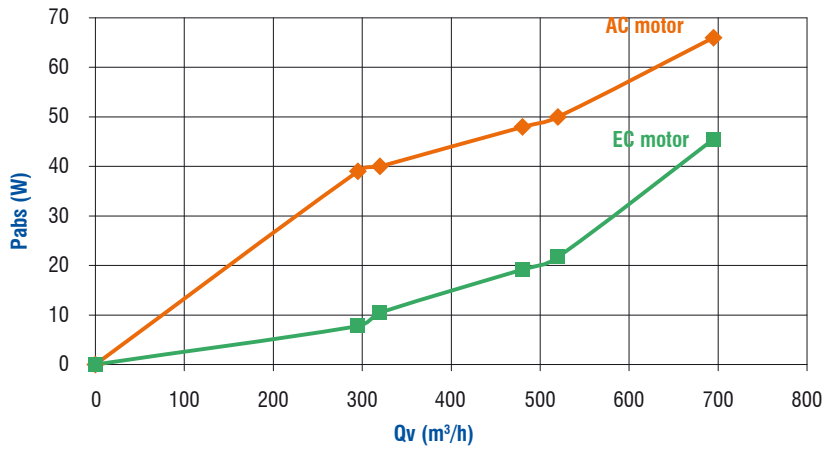

Aqu@Fan II size 60

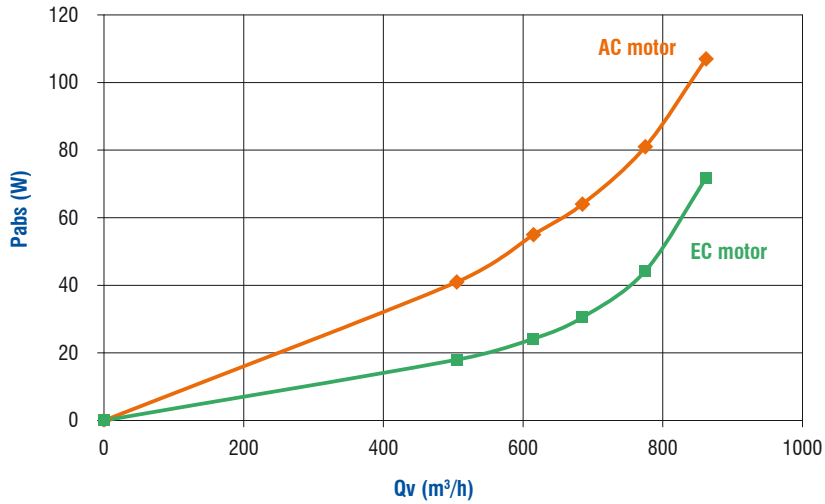

Operating range with EC motor : Voltage setpoint

Models	Minimum starting voltage (V)	Minimum voltage with electric heater (V)	Maximum optimized voltage (V)
20	1.5	2.5	6.0
30	1.5	3.0	6.5
40	1.5	3.0	6.5
50	1.5	3.0	7.0
60	1.5	3.0	10.0

Aqu@Fan II AWC Models - Mounting Accessories

Options and accessories

STD	standard version for wall mounting (no support feet supplied).
MP	support feet for floor mounting.
MPG	air intake grille between feet.
RF	front air intake grille (no support feet supplied).
RP	back partial air intake with support feet.
RT	back full air intake with support feet.
RC	floor air intake with support feet.
RVCA-RT	air intake arrangement with motorized (non controlled) on/off damper (back or front intake).
RVCA-RC	air intake arrangement with motorized (non controlled) on/off damper (floor or front intake).
RVCM-RT	air intake arrangement with manual damper (back or/and front intake).
RVCM-RC	air intake arrangement with manual damper (floor or/and front intake).
TMT	telescopic wall sleeve.
TMTG	telescopic wall sleeve with external grille (filter not supplied).
RH	cabinet backwrap for plinth.
ALV	finished back panel (for unit mounted in front of glass wall).
BAC	auxiliary drain pan (for units without motorized valves).
FLOOR FIX	floor fixing brackets (for MP and ALV).

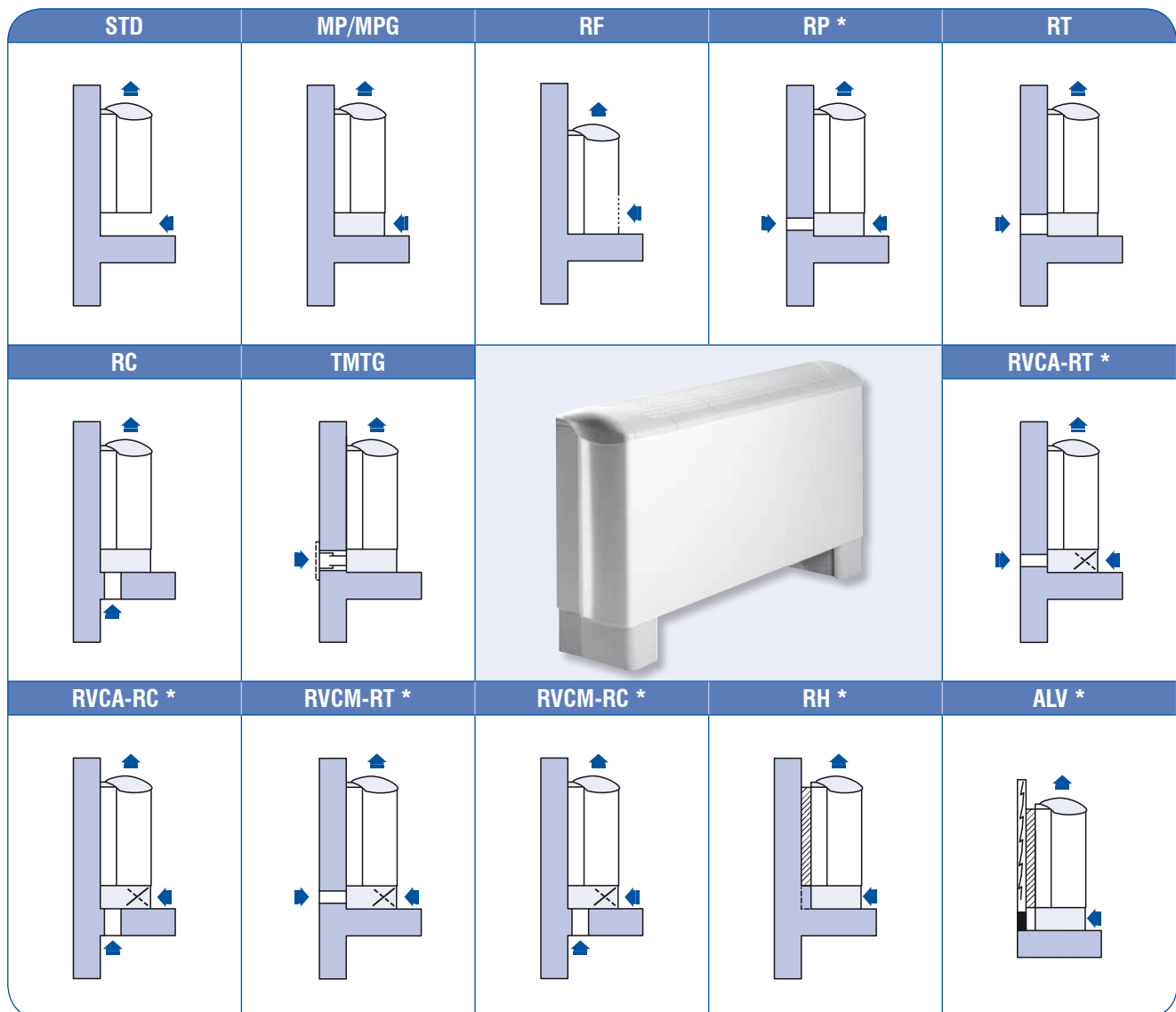

* Can be fitted with optional intake grille between feet.

Aqu@Fan II AWN Models - Mounting Accessories

Options and accessories

STD	standard version for wall mounting (no support feet supplied).
MP	support feet for floor mounting.
RD	front air intake.
RP	back partial air intake with support feet.
RT	back full air intake with support feet.
RC	floor air intake with support feet.
RVCA-RT	air intake arrangement with motorized (non controlled) on/off damper (back or front intake).
RVCA-RC	air intake arrangement with motorized (non controlled) on/off damper (floor or front intake).
RVCM-RT	air intake arrangement with manual damper (back or/and front intake).
RVCM-RC	air intake arrangement with manual damper (floor or/and front intake).
TMT	telescopic wall sleeve.
TMTG	telescopic wall sleeve with external grille (filter not supplied).
BAC	auxiliary drain pan (for units without motorized valves).
CRG	discharge duct collar.

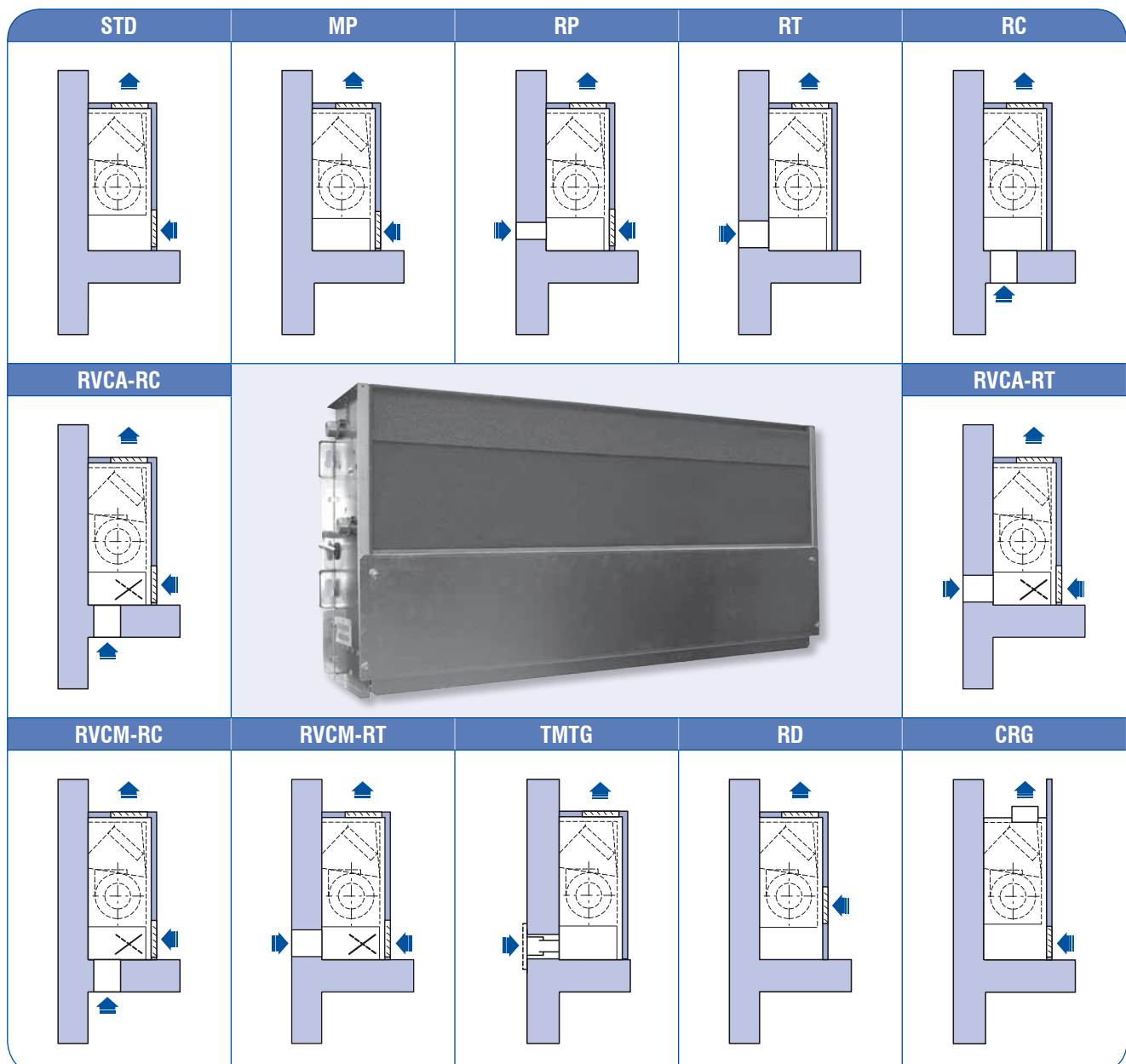

Aqu@Fan II AHC Models - Mounting Accessories

Options and accessories

STD	standard ceiling mounted version with rear air intake (no inlet grille).
RF	bottom air intake grille.
RVCA-RC	air intake arrangement with motorized (non controlled) on/off damper.
RVCM-RC	air intake arrangement with manual damper.
RC	rear air intake with support feet.
MP	support feet.
MPG	air intake grille between feet.
THI	return air perforated panel with filter media.
TMT	telescopic wall sleeve.
TMTG	telescopic wall sleeve with external grille (filter not supplied).
BAC	auxiliary painted drain pan (for units without motorized valves).

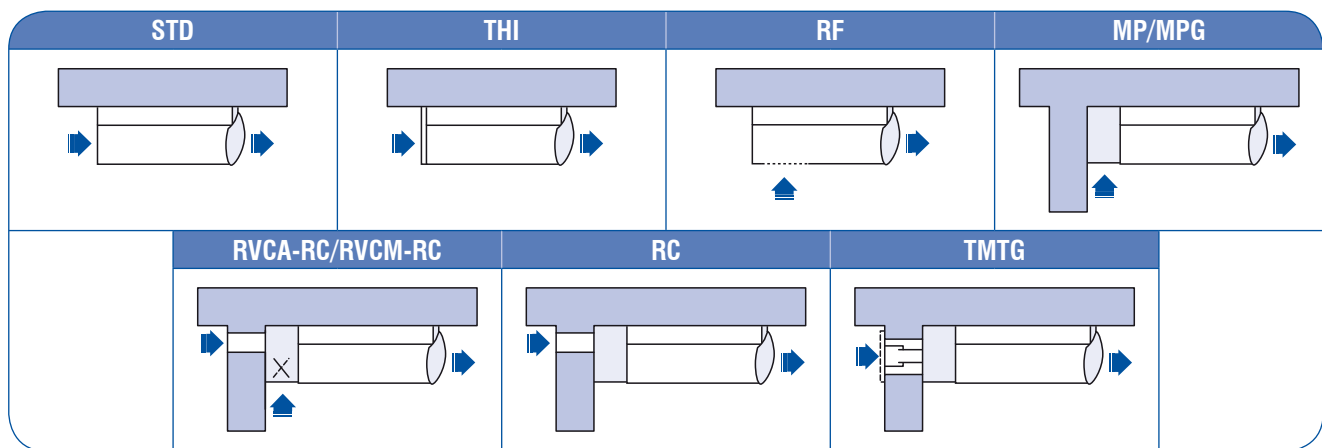

Aqu@Fan II AHN Models - Mounting Accessories

Options and accessories

STD	standard ceiling mounted version with rear air intake (no inlet grille).
RVCA-RC	air intake arrangement with motorized (non controlled) on/off damper.
RVCM-RC	air intake arrangement with manual damper.
RD	bottom air intake.
RC	rear air intake with support feet.
CRG	discharge duct collar.
TMT	telescopic wall sleeve.
TMTG	telescopic wall sleeve with external grille (filter not supplied).
BAC	auxiliary painted drain pan (for units without motorized valves).

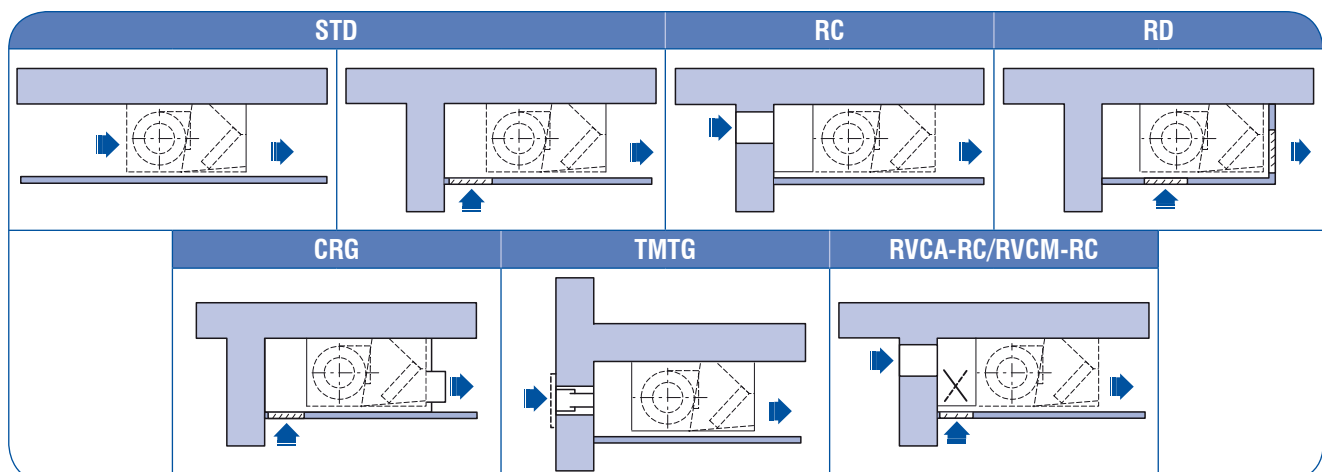

Aqu@Fan II - Available Options

Coils

		AWC	AWN	AHC	AHN
XX20	2 row main coil - 2 pipe system	Yes	Yes	Yes	Yes
XX30	3 row main coil - 2 pipe system	Yes	Yes	Yes	Yes
XX21	2 row main coil + 1-row additional coil - 4 pipe system	Yes	Yes	Yes	Yes
XX31	3 row main coil + 1-row additional coil - 4 pipe system	Yes	Yes	Yes	Yes
XX20E	2 row main coil + standard electric heating coil - 2 pipe / 2 wire system	Yes	Yes	Yes	Yes
XX30E	3 row main coil + standard electric heating coil - 2 pipe / 2 wire system	Yes	Yes	Yes	Yes

Note : XX = size of unit (for example : 1020 = fan coil size 10 with 2-row main coil - 2 pipe system).

2-way control valve - 2-pipe system - 230 Volt (or optional 24 Volt) thermal actuator

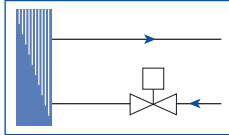

W2G1	1 valve, 2-way type - For 2-pipe system on cooling or heating coil						
	Valve		Thermal attenuator 230 V - 50/60 Hz				
Sizes	KV	Ø	T max amb	T max fluid	Id (A)	In (A)	P (VA)
10/60	1.6	1/2"	50 °C	110 °C	0.6	0.013	3.0
70/90	2.5	3/4"	50 °C	110 °C	0.6	0.013	3.0

2-way control valve - 4-pipe system - 230 Volt (or optional 24 Volt) thermal actuator

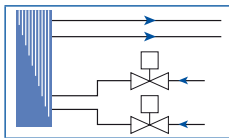
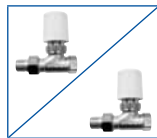

W2G2	2 valves, 2-way type - For 4-pipe system on cooling and heating coils								
	Cooling valve		Heating valve		Thermal actuator(s) 230 V - 50/60 Hz				
Sizes	KV	Ø	KV	Ø	T max amb	T max fluid	Id (A)	In (A)	P (VA)
10/60	1.6	1/2"	1.6	1/2"	50 °C	110 °C	0.6	0.013	3.0
70/90	2.5	3/4"	1.6	1/2"	50 °C	110 °C	0.6	0.013	3.0

4-way control valve - 2-pipe system - 230 Volt (or optional 24 Volt) thermal actuator

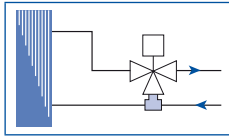

W4G1	1 valve, 4-way type - For 2-pipe system on cooling or heating coil						
	Valve		Thermal actuator 230 V - 50/60 Hz				
Sizes	KV	Ø	T max amb	T max fluid	Id (A)	In (A)	P (VA)
10/60	1.6	1/2"	50 °C	110 °C	0.6	0.013	3.0
70/90	2.5	3/4"	50 °C	110 °C	0.6	0.013	3.0

4-way control valve - 4-pipe system - 230 Volt (or optional 24 Volt) thermal actuator

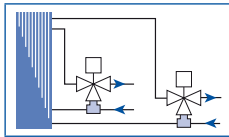
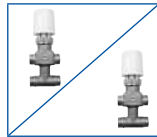

W4G2	2 valves, 4-way type - For 4-pipe system on cooling and heating coils								
	Cooling valve		Heating valve		Thermal actuator(s) 230 V - 50/60 Hz				
Sizes	KV	Ø	KV	Ø	T max amb	T max fluid	Id (A)	In (A)	P (VA)
10/60	1.6	1/2"	1.6	1/2"	50 °C	110 °C	0.6	0.013	3.0
70/90	2.5	3/4"	1.6	1/2"	50 °C	110 °C	0.6	0.013	3.0

2-way control valve - 2-pipe system - 3-point modulating actuator*

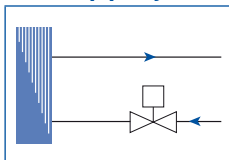

W2G1	1 valve, 2-way type - For 2-pipe system on cooling or heating coil				
	Valve		24 Volts actuator - 50/60 Hz		
Sizes	KV	Ø	T max amb	T max fluid	P (VA)
10/20	0.6	1/2"	60 °C	110 °C	7.0
30/60	1.6	1/2"	60 °C	110 °C	7.0
70/90	2.5	3/4"	60 °C	110 °C	7.0

2-way control valve - 4-pipe system - 3-point modulating actuator*

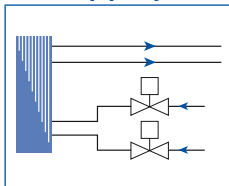

W2G2	2 valves, 2-way type - For 4-pipe system on cooling and heating coils						
	Cooling valve		Heating valve		24 Volts actuator - 50/60 Hz		
Sizes	KV	Ø	KV	Ø	T max amb	T max fluid	P (VA)
10/20	0.6	1/2"	0.6	1/2"	60 °C	110 °C	7.0
30/40	1.6	1/2"	0.6	1/2"	60 °C	110 °C	7.0
50/60	1.6	1/2"	1.6	1/2"	60 °C	110 °C	7.0
70/90	2.5	3/4"	1.6	1/2"	60 °C	110 °C	7.0

4-way control valve - 2-pipe system - 3-point modulating actuator*

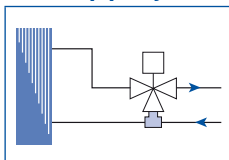

W4G1	1 valve, 4-way type - For 2-pipe system on cooling or heating coil				
	Valve		24 Volts actuator - 50/60 Hz		
Sizes	KV	Ø	T max amb	T max fluid	P (VA)
10/20	0.6	1/2"	60 °C	110 °C	7.0
30/60	1.6	1/2"	60 °C	110 °C	7.0
70/90	2.5	3/4"	60 °C	110 °C	7.0

4-way control valve - 4-pipe system - 3-point modulating actuator*

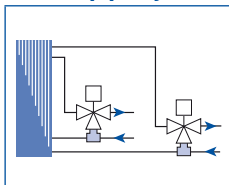
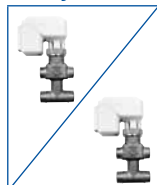

W4G2	2 valves, 4-way type - For 4-pipe system on cooling and heating coils						
	Cooling valve		Heating valve		24 Volts actuator - 50/60 Hz		
Sizes	KV	Ø	KV	Ø	T max amb	T max fluid	P (VA)
10/20	0.6	1/2"	0.6	1/2"	60 °C	110 °C	7.0
30/40	1.6	1/2"	0.6	1/2"	60 °C	110 °C	7.0
50/60	1.6	1/2"	1.6	1/2"	60 °C	110 °C	7.0
70/90	2.5	3/4"	1.6	1/2"	60 °C	110 °C	7.0

(* Actuator available with Honeywell or similar digital controllers (consult factory).

Aqu@Fan II - Main Controls (Optional)

CMV (supplied fitted)
Manual fan speed selector

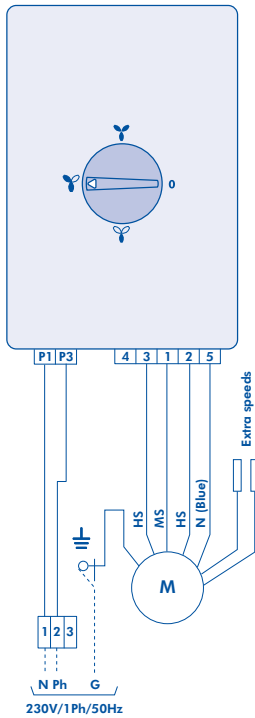

	AWC	✓
	AWN	✓
	AHC	✓
	AHN	✗

TBV (supplied fitted)
Electromechanical control with valve

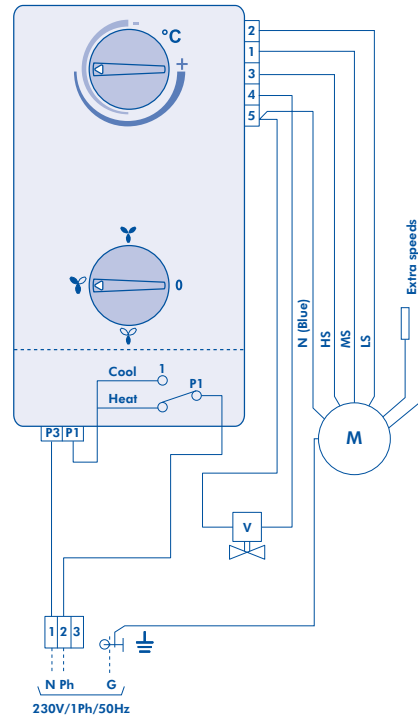

	AWC	✓
	AWN	✓
	AHC	✓
	AHN	✗

- ▶ 4 position manual fan speed selector : OFF/LS/MS/HS.

- ▶ Action on valve and fan, 2-pipe system in heating or cooling mode.
- ▶ Set of thermostat + 4-position manual speed selector : OFF/LS/MS/HS.
- ▶ Option TBV1 for action on valve only with constant fan operation.
- ▶ For reversible 2-pipe system with summer/winter automatic changeover, possibility of mounting with a water changeover sensor PCO, use of 4-way valve is mandatory.

TBMV (supplied fitted)
Electromechanical control with valve(s)

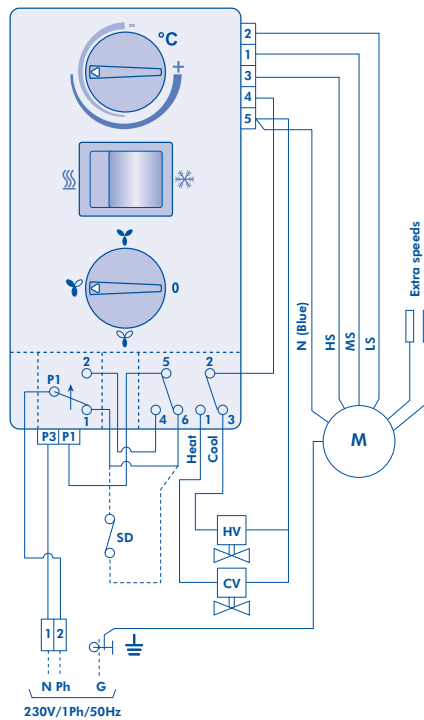

	AWC	✓
	AWN	✓
	AHC	✓
	AHN	✗

- ▶ Action on valves and fan, 4-pipe, 2-pipe/2-wire or manual changeover 2-pipe system.
- ▶ Set of thermostat + summer/winter selector + 4-position manual speed selector: OFF/LS/MS/HS.
- ▶ Option TBMV1 for action on valve(s) only with constant fan operation.
- ▶ For 4-pipe or manual changeover 2-pipe system, possibility of mounting a low temperature cut-out sensor SD (temp. range 45 °C/35 °C) on hot water piping to stop fan operation.

Aqu@Fan II - Main Controls (Optional) (continued)

CMVM (supplied loose) Manual fan speed selector

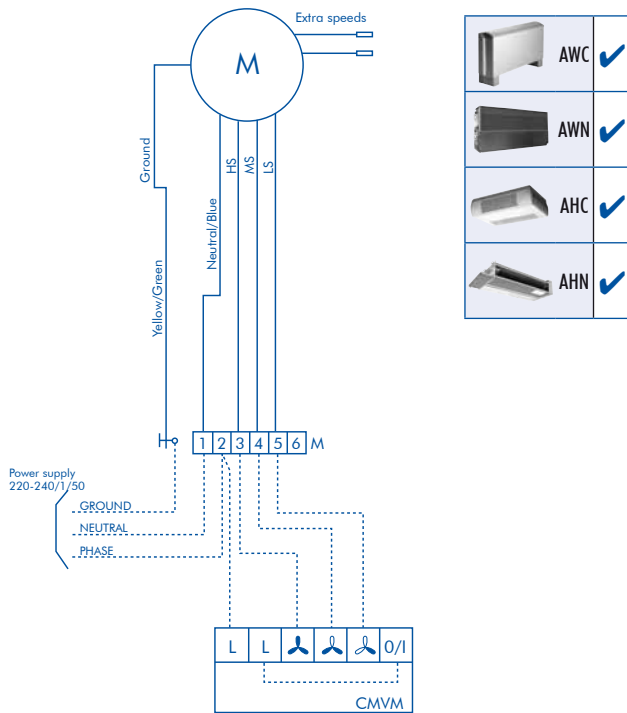

TRM-FA (supplied loose) Electromechanical remote control

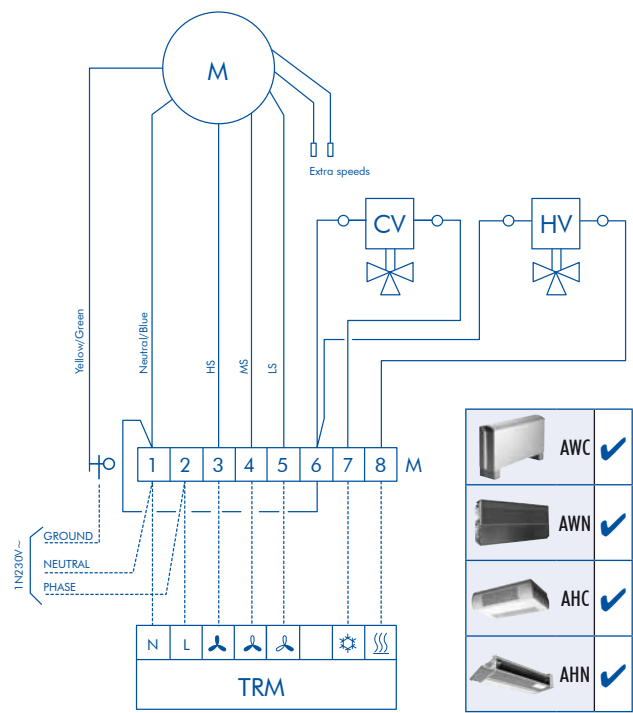

▶ 4 position manual fan speed selector : OFF/LS/MS/HS.

- ▶ Wall mounted remote thermostat to control valves and fan.
- ▶ Suitable for 4-pipe (with cooling and heating valves), 2-pipe/2-wire (with cooling valve and electric heater), 2-pipe (with cooling or heating valve) and reversible 2-pipe (with manual changeover) systems.
- ▶ Control buttons : ON/OFF; Summer/Winter changeover; Manual fan speed selector : LS/MS/HS.

TRM-VP (supplied loose) Electromechanical remote control

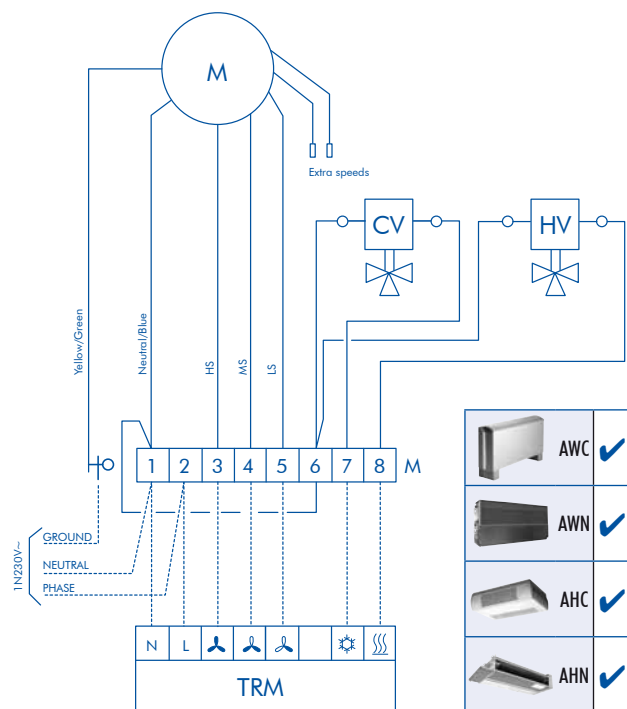

TAE20 (supplied loose) Electronic remote thermostat

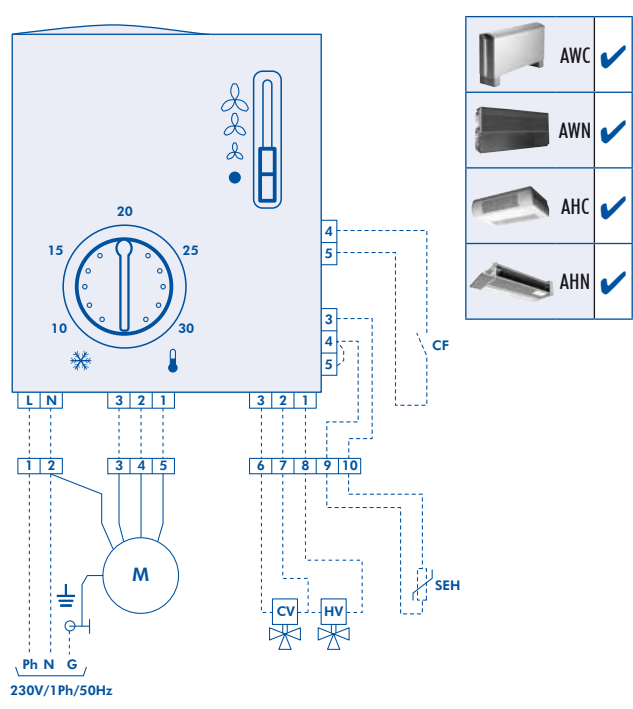

- ▶ Wall mounted remote thermostat to regulate control valve(s).
- ▶ Suitable for 4-pipe (with cooling and heating valves), 2-pipe/2-wire (with cooling valve and electric heater), 2-pipe (with cooling or heating valve) and reversible 2-pipe (with manual changeover) systems.
- ▶ Control buttons : ON/OFF; Summer/Winter changeover; Manual fan speed selector : LS/MS/HS.

- ▶ Adjustable dead zone electronic thermostat with summer/winter automatic changeover.
- ▶ Suitable for 4-pipe (with cooling and heating valves), 2-pipe/2-wire (with cooling valve and electric heater (TAE 20BE)), 2-pipe (with cooling or heating valve) or reversible 2-pipe (with or without extra electric heating, 4-way valve mandatory and SEH changeover sensor) system.
- ▶ Controls buttons : ON/OFF, manual fan speed selector : LS/MS/HS, NO (normally open) or NC (normally closed) window contact CF.

Aqu@Fan II - Main Controls (Optional) (continued)

Aqu@Net communicating electronic control FCC electronic controller (supplied fitted)

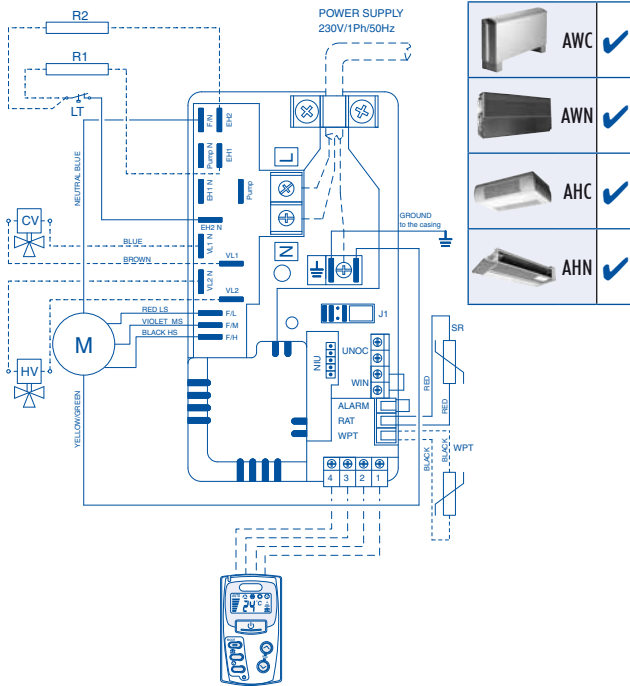

RCL wire remote control with digital display (supplied loose or fitted)

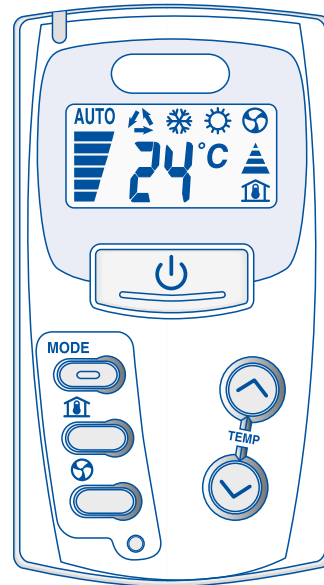

- ▶ Controller can be configured in 2-pipe heating only or cooling only, 2-pipe/2-wire, reversible 2-pipe with or without extra electric heating or 4-pipe system.
- ▶ Other pre-programmed functionalities included : master/slaves up to 15 units controlled from one remote control only; NC window contact; automatic or manual selection of unoccupied mode; antifreeze mode.

- ▶ Wire remote control for wall mounting or for mounting on AWC units.
- ▶ Keyboard with locking device and buttons : ON/Standby; fan operation (auto or manual); operation mode (cooling, heating, auto or fan operation only); temperature setpoint adjustment in different modes.
- ▶ Functioning LED.

μBMS programmable supervision station (supplied loose)

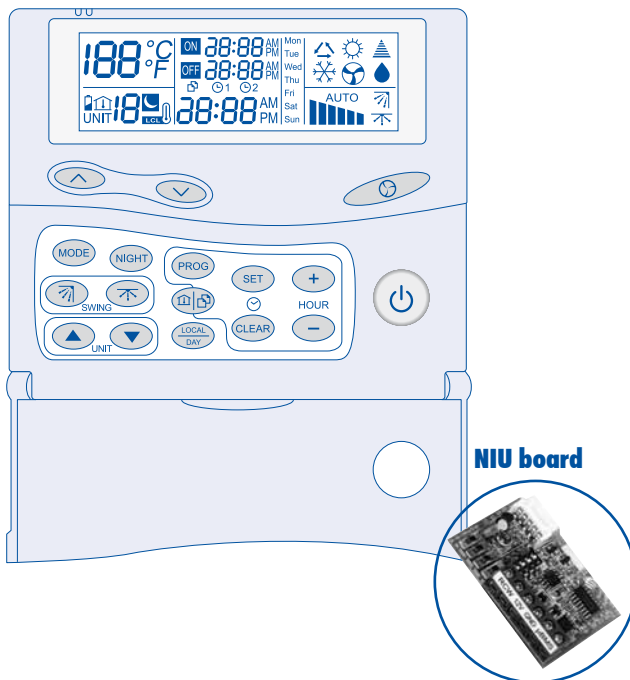

Aqu@Net communicating electronic control System networking

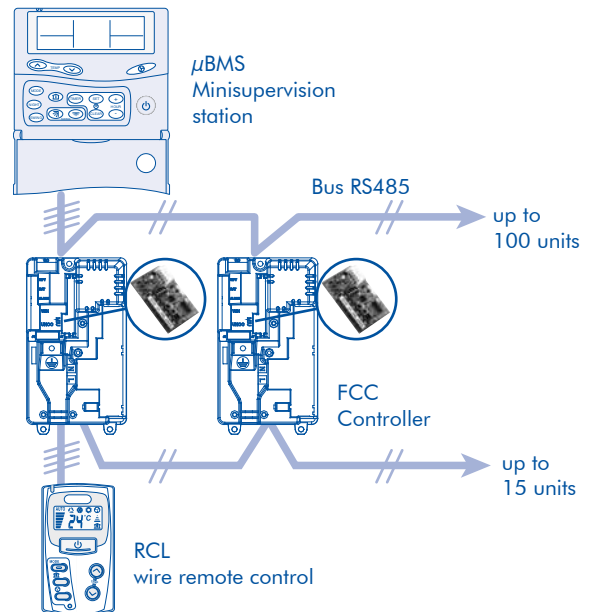

- ▶ In association with FCC controllers through a communication bus and interface board (NIU), μBMS allows 15 different zones with 100 units to be managed.
- ▶ Other functionalities included either in global or individual control by zone :
 - Daily and weekly programming of running times (2 hour ranges),
 - Programming and setting of temperature setpoints (cooling, heating, auto),
 - Choice of operation mode (cooling, heating, auto or fan operation only),
 - Choice of fan operation speed (auto or manual).

- ▶ RS485 communication bus system allowing user to monitor 100 fan coil units through a supervision station (μBMS), with FCC Aqu@Net controllers fitted with interface boards (NIU) and with local controls (RCL).
Max. length of bus = 1000 meters, shielded twisted pair cable.

Aqu@Fan II - Technical Data

Air flow - 2-row dry coil

Unit sizes		10	20	30	40	50	60	70	80	90
Speed 1	m ³ /h	190	334	428	600	775	965	1210	1448	1828
Speed 2	m ³ /h	168	297	368	495	583	810	1126	1125	1601
Speed 3	m ³ /h	144	235	305	405	496	684	841	983	1394
Speed 4	m ³ /h	123	187	266	370	378	624	690	836	1115
Speed 5	m ³ /h	103	139	191	311	351	493	574	700	822

Air flow - 3-row dry coil

Speeds	1030	2030	3030	4030	5030	6030	7030	8030	9030
V1	181	317	407	570	736	917	1150	1376	1737
V2	160	282	350	470	554	770	1070	1069	1521
V3	137	223	290	385	471	650	799	934	1324
V4	117	178	253	352	359	593	656	793	1058
V5	98	132	181	295	333	468	545	665	782

Electrical data 230 V/1 Ph/50 Hz (standard motor)

Unit sizes		10	20	30	40	50	60	70	80	90
Max. running absorbed power (W)	V1	34	45	60	57	66	107	150	188	291
	V2	28	37	49	47	50	81	130	132	222
	V3	24	27	40	39	45	64	110	112	200
	V4	20	19	33	36	40	55	101	101	165
	V5	17	16	24	33	39	41	92	90	140
Max. absorbed current (A)		0.13	0.17	0.28	0.27	0.31	0.5	0.7	0.95	1.5

Note : Data compatible with 60 Hz, except size 70.

Water volume (liters)

Sizes	Water volume (liters)		
	1-row	2-row	3-row
10	0.17	0.29	0.41
20	0.24	0.43	0.62
30	0.34	0.62	0.90
40	0.43	0.80	1.18
50	0.52	0.99	1.46
60	0.61	1.17	1.73
70	0.69	1.49	2.19
80	0.92	1.76	2.60
90	1.06	2.04	3.60

Operating limits

Environmental conditions	Minimum premise air temperature / new air intake / around the apparatus	5 °C / 15% RH
	Maximale premise air temperature / new air intake / around the apparatus	32 °C / 70% RH
Water circuit	Max. operating pressure	17 bars
	Min. entering water temperature	+6 °C
	Max. entering water temperature	+90 °C

Aqu@Fan II - Optional Electric Heating Coil Data

Electric heaters with heating rods supplied fitted

	BE1	BE2	BE3	BE4
10	200	400	600 ⁽¹⁾ (200+400)	NA
20	300	600	900 ⁽¹⁾ (300+600)	NA
30	300	600	900 ⁽¹⁾ (300+600)	1200 ⁽¹⁾ (600+600)
40	500	1000	1500 ⁽¹⁾ (500+1000)	2000 ⁽¹⁾ (1000+1000)
50	600	1200	1800 ⁽¹⁾ (600+1200)	2400 ⁽¹⁾ (1200+1200)
60	750	1500	2250 ⁽¹⁾ (750+1500)	3000 ⁽¹⁾ (1500+1500)
70	750	1500	2250 ⁽¹⁾ (750+1500)	3000 ⁽¹⁾ (1500+1500)
80	900	1800	2700 ⁽¹⁾ (900+1800)	3600 ⁽¹⁾ (1800+1800)
90	1000	2000	3000 ⁽¹⁾ (1000+2000)	4000 ⁽¹⁾ (2000+2000)

(1) Available in 2 steps suitable for Aqu@Net control.
 NA : Not available.

Electric heaters with heating rods supplied loose

	BE1	BE2	BE3	BE4
20	300	600	900 ⁽¹⁾ (300+600)	NA
30	300	600	900 ⁽¹⁾ (300+600)	1200 ⁽¹⁾ (600+600)
40	500	1000	1500 ⁽¹⁾ (500+1000)	2000 ⁽¹⁾ (1000+1000)
50	600	1200	1800 ⁽¹⁾ (600+1200)	2400 ⁽¹⁾ (1200+1200)
60	750	1500	2250 ⁽¹⁾ (750+1500)	3000 ⁽¹⁾ (1500+1500)
70	750	1500	2250 ⁽¹⁾ (750+1500)	3000 ⁽¹⁾ (1500+1500)

(1) Available in 2 steps suitable for Aqu@Net control.
 NA : Not available.

Performance Data Aqu@Fan II - 2-pipe System

2-row main coil

Sizes	Speeds	Humid air flow (m³/h)	Cooling			Heating	
			Pt (W)	Ps (W)	WPD (kPa)	Pc (W)	WPD (kPa)
1020	V1	175	0.91	0.79	10.1	1.31	8.14
	V2	155	0.85	0.74	9.00	1.20	7.37
	V3	132	0.77	0.66	7.40	1.06	6.29
	V4	113	0.67	0.57	5.80	0.93	4.89
	V5	95	0.57	0.48	4.40	0.78	3.83
2020	V1	307	1.73	1.28	35.8	2.02	32.0
	V2	273	1.60	1.16	31.0	1.92	27.2
	V3	216	1.35	0.96	23.0	1.65	20.1
	V4	172	1.15	0.80	17.1	1.37	14.9
	V5	128	0.97	0.66	12.7	1.04	10.9
3020	V1	394	1.99	1.79	8.00	3.00	6.83
	V2	339	1.91	1.66	7.50	2.69	6.46
	V3	281	1.76	1.44	6.50	2.39	5.42
	V4	245	1.63	1.28	5.60	2.10	4.70
	V5	176	1.30	0.94	3.70	1.71	3.14
4020	V1	552	3.01	2.44	17.7	3.91	19.5
	V2	455	2.65	2.04	14.1	3.64	15.4
	V3	373	2.25	1.73	10.5	3.10	11.8
	V4	340	2.13	1.60	9.50	2.90	10.3
	V5	286	1.91	1.41	7.80	2.54	8.60
5020	V1	713	3.73	2.83	28.3	5.35	24.0
	V2	536	3.26	2.54	22.1	4.32	18.6
	V3	456	2.92	2.22	18.2	3.84	15.3
	V4	348	2.35	1.77	12.3	3.20	10.4
	V5	323	2.21	1.65	11.4	3.04	9.10
6020	V1	888	4.91	3.34	29.3	6.41	24.6
	V2	745	4.25	2.88	22.6	5.51	18.9
	V3	629	3.80	2.56	18.5	4.72	15.5
	V4	574	3.56	2.38	16.4	4.39	13.9
	V5	454	2.99	2.08	12.1	3.63	10.3
7020	V1	1113	5.70	4.65	35.6	7.63	27.0
	V2	1036	5.22	4.05	29.6	6.66	21.5
	V3	774	4.40	3.36	22.0	5.53	16.1
	V4	635	3.86	2.93	17.3	4.89	12.6
	V5	528	3.17	2.39	12.2	4.09	8.90
8020	V1	1333	7.86	6.33	42.2	9.87	35.9
	V2	1035	6.66	5.30	30.1	8.44	26.8
	V3	905	5.87	4.65	24.0	7.64	21.2
	V4	769	5.01	3.97	18.0	6.28	16.1
	V5	644	4.20	3.33	13.2	5.14	11.7
9020	V1	1682	9.15	7.12	76.6	12.2	72.4
	V2	1473	8.80	6.62	69.4	11.2	65.3
	V3	1282	8.22	6.00	61.4	10.3	57.5
	V4	1026	7.23	5.14	48.6	8.82	45.8
	V5	756	6.05	4.20	35.3	7.36	33.4

Performances based on :

Summer : air 27 °C/19 °C (wet bulb) and chilled water 7/12 °C.

Winter : air 20 °C, entering water temperature 50 °C, water flow identical to cooling mode.

Pt : Total cooling capacity.

Ps : Sensible cooling capacity.

Pc : Heating capacity.

WPD : Water pressure drop.

 Standard wiring of the 3 speeds. Other speed combinations available upon request.

Performance Data Aqu@Fan II - 2-pipe System

3-row main coil

Sizes	Speeds	Humid air flow (m³/h)	Cooling			Heating	
			Pt (W)	Ps (W)	WPD (kPa)	Pc (W)	WPD (kPa)
1030	V1	167	1.14	0.88	19.0	1.58	16.0
	V2	147	1.07	0.81	16.0	1.47	14.0
	V3	126	0.96	0.71	13.0	1.29	11.0
	V4	108	0.83	0.62	11.0	1.09	9.00
	V5	90	0.72	0.52	8.00	0.93	7.00
2030	V1	292	1.87	1.48	8.00	2.53	8.00
	V2	259	1.75	1.35	7.00	2.39	7.00
	V3	205	1.47	1.11	5.00	2.02	5.00
	V4	164	1.26	0.93	4.00	1.65	4.00
	V5	121	1.04	0.75	3.00	1.24	3.00
3030	V1	374	2.44	1.94	16.0	3.40	13.0
	V2	322	2.28	1.73	15.0	3.02	12.0
	V3	267	2.13	1.56	12.0	2.61	11.0
	V4	233	1.92	1.39	10.0	2.29	9.00
	V5	167	1.52	1.02	7.00	1.74	6.00
4030	V1	524	3.46	2.73	33.0	4.57	28.0
	V2	432	3.08	2.35	26.0	4.18	22.0
	V3	354	2.62	1.97	20.0	3.50	17.0
	V4	324	2.47	1.83	18.0	3.23	15.0
	V5	271	2.19	1.60	14.0	2.69	12.0
5030	V1	677	4.22	2.98	29.0	5.41	24.0
	V2	510	3.17	2.20	17.0	4.26	15.0
	V3	433	2.8	1.92	14.0	3.71	12.0
	V4	330	2.24	1.52	9.00	3.05	8.00
	V5	306	2.10	1.42	8.00	2.83	7.00
6030	V1	844	5.73	3.85	42.0	7.36	35.0
	V2	708	4.94	3.27	32.0	6.18	27.0
	V3	598	4.39	2.86	26.0	5.25	22.0
	V4	546	4.08	2.64	23.0	4.85	19.0
	V5	431	3.40	2.22	16.0	3.99	14.0
7030	V1	1058	7.21	5.64	25.0	9.18	21.0
	V2	984	6.84	5.17	22.0	8.41	19.0
	V3	735	5.61	4.17	16.0	6.90	13.0
	V4	604	4.81	3.56	12.0	6.01	12.0
	V5	501	3.92	2.89	8.00	4.94	7.00
8030	V1	1266	9.04	6.89	39.0	11.3	33.0
	V2	983	7.59	5.62	29.0	9.27	24.0
	V3	859	6.65	4.92	23.0	8.36	19.0
	V4	730	5.68	4.19	17.0	7.11	14.0
	V5	612	4.75	3.51	12.0	5.99	10.0
9030	V1	1598	10.5	7.84	49.2	14.0	44.6
	V2	1399	9.98	7.49	44.0	12.8	37.8
	V3	1218	9.01	6.74	36.2	11.5	32.4
	V4	973	7.69	5.65	27.2	9.80	24.3
	V5	719	6.42	4.53	19.4	7.53	17.6

Performances based on :

Summer : air 27 °C/19 °C (wet bulb) and chilled water 7/12 °C.

Winter : air 20 °C, entering water temperature 50 °C, water flow identical to cooling mode.

Pt : Total cooling capacity.

Ps : Sensible cooling capacity.

Pc : Heating capacity.

WPD : Water pressure drop.

 Standard wiring of the 3 speeds. Other speed combinations available upon request.

Performance Data Aqu@Fan II - 4-pipe System

2-row cooling main coil + 1-row heating complementary coil

Sizes	Speeds	Humid air flow (m³/h)	Cooling			Heating	
			Pt (W)	Ps (W)	WPD (kPa)	Pc (W)	WPD (kPa)
1021	V1	167	0.96	0.76	9.50	1.46	2.00
	V2	147	0.90	0.71	8.40	1.38	1.80
	V3	126	0.81	0.64	7.00	1.28	1.57
	V4	108	0.70	0.55	5.50	1.16	1.32
	V5	90	0.60	0.46	4.10	1.02	1.07
2021	V1	292	1.68	1.35	31.6	2.50	5.71
	V2	259	1.55	1.23	27.6	2.41	5.36
	V3	205	1.30	1.01	20.2	2.14	4.34
	V4	164	1.11	0.84	15.0	1.85	3.38
	V5	121	0.93	0.69	11.0	1.50	2.34
3021	V1	374	2.04	1.72	7.60	3.40	13.1
	V2	322	1.81	1.50	7.10	3.15	11.5
	V3	267	1.65	1.34	6.00	2.85	9.67
	V4	233	1.50	1.23	5.20	2.63	8.31
	V5	167	1.06	0.90	3.40	2.20	6.08
4021	V1	524	2.92	2.23	16.8	4.73	29.5
	V2	432	2.57	1.87	13.4	4.30	25.0
	V3	354	2.17	1.57	9.90	3.80	19.9
	V4	324	2.06	1.46	8.90	3.59	18.0
	V5	271	1.84	1.28	7.30	3.27	15.4
5021	V1	677	3.83	3.06	40.1	4.98	75.6
	V2	510	2.86	2.26	23.7	4.30	58.0
	V3	433	2.56	1.97	19.4	3.88	48.3
	V4	330	2.05	1.57	13.0	3.26	35.3
	V5	306	1.93	1.46	12.1	3.08	32.0
6021	V1	844	4.76	3.24	27.7	6.15	15.7
	V2	708	4.12	2.79	21.4	5.64	13.5
	V3	598	3.68	2.48	17.5	5.20	11.6
	V4	546	3.44	2.30	15.4	4.94	10.6
	V5	431	2.88	2.01	11.3	4.25	8.16
7021	V1	1057	5.70	4.65	35.6	8.00	24.3
	V2	984	5.22	4.05	27.9	7.17	18.6
	V3	735	4.40	3.36	20.7	6.27	14.7
	V4	604	3.86	2.93	16.2	5.69	12.3
	V5	501	3.17	2.39	11.5	4.80	8.99
8021	V1	1266	7.62	6.10	40.0	11.8	49.0
	V2	983	6.44	5.08	28.3	10.4	39.6
	V3	859	5.67	4.46	22.6	9.61	34.3
	V4	730	4.84	3.81	17.0	8.67	28.5
	V5	612	4.05	3.19	12.4	7.40	21.3
9021	V1	1598	9.06	7.02	57.3	14.2	74.4
	V2	1399	8.54	6.41	51.7	13.5	67.2
	V3	1218	7.97	5.81	45.6	12.5	58.9
	V4	974	6.98	4.96	35.9	11.0	46.6
	V5	719	5.81	4.04	25.8	9.11	33.4

Performances based on :

Summer : air 27 °C/19 °C (wet bulb) and chilled water 7/12 °C.

Winter : air 20 °C, hot water 70/60 °C.

Pt : Total cooling capacity.

Ps : Sensible cooling capacity.

Pc : Heating capacity.

WPD : Water pressure drop.

 Standard wiring of the 3 speeds. Other speed combinations available upon request.

Performance Data Aqu@Fan II - 4-pipe System

3-row cooling main coil + 1-row heating complementary coil

Sizes	Speeds	Humid air flow (m³/h)	Cooling			Heating	
			Pt (W)	Ps (W)	WPD (kPa)	Pc (W)	WPD (kPa)
1031	V1	161	1.11	0.86	18.0	1.44	2.00
	V2	143	1.04	0.78	16.0	1.36	2.00
	V3	122	0.93	0.69	13.0	1.25	2.00
	V4	104	0.80	0.60	10.0	1.13	1.00
	V5	87	0.70	0.51	8.00	1.00	1.00
2031	V1	282	1.97	1.52	42.0	2.32	6.00
	V2	251	1.85	1.39	37.0	2.23	5.00
	V3	199	1.54	1.14	27.0	1.98	4.00
	V4	158	1.33	0.95	20.0	1.71	3.00
	V5	118	1.08	0.76	14.0	1.39	2.00
3031	V1	362	2.39	1.88	15.0	3.34	13.0
	V2	312	2.20	1.65	14.0	3.10	11.0
	V3	259	2.08	1.52	12.0	2.80	9.00
	V4	225	1.87	1.35	10.0	2.58	8.00
	V5	161	1.48	0.99	7.00	2.16	6.00
4031	V1	508	3.40	2.66	31.0	4.54	25.0
	V2	419	3.01	2.29	25.0	4.23	22.0
	V3	343	2.56	1.92	19.0	3.73	17.0
	V4	314	2.41	1.78	17.0	3.52	16.0
	V5	263	2.13	1.55	14.0	3.21	13.0
5031	V1	656	4.22	3.00	20.5	5.25	50.0
	V2	493	3.68	2.71	16.0	4.51	38.0
	V3	420	3.25	2.37	13.0	4.01	32.0
	V4	320	2.59	1.88	9.00	3.43	23.0
	V5	297	2.43	1.74	8.00	3.23	21.0
6031	V1	817	5.61	3.77	40.0	6.06	15.0
	V2	685	4.84	3.20	31.0	5.55	13.0
	V3	579	4.29	2.80	25.0	5.11	11.0
	V4	528	3.98	2.58	22.0	4.86	10.0
	V5	417	3.31	2.17	16.0	4.18	8.00
7031	V1	1024	7.12	5.54	24.0	6.98	24.0
	V2	953	6.68	5.04	21.0	6.26	19.0
	V3	712	5.47	4.06	15.0	5.27	15.0
	V4	584	4.69	3.46	11.0	4.96	12.0
	V5	486	3.81	2.81	8.00	4.28	9.00
8031	V1	1226	8.83	6.71	38.0	11.6	48.0
	V2	952	7.40	5.46	28.0	10.3	38.0
	V3	832	6.49	4.78	22.0	9.43	33.0
	V4	707	5.54	4.08	16.0	8.14	25.0
	V5	592	4.63	3.41	12.0	6.75	18.0
9031	V1	1547	10.0	7.28	41.0	14.0	73.0
	V2	1355	9.76	5.82	39.5	13.2	65.0
	V3	1179	8.80	5.24	33.3	12.3	57.0
	V4	944	7.50	4.37	24.7	10.8	45.0
	V5	696	6.23	3.96	17.8	8.92	32.0

Performances based on :

Summer : air 27 °C/19 °C (wet bulb) and chilled water 7/12 °C.

Winter : air 20 °C, hot water 70/60 °C.

Pt : Total cooling capacity.

Ps : Sensible cooling capacity.

Pc : Heating capacity.

WPD : Water pressure drop.

 Standard wiring of the 3 speeds. Other speed combinations available upon request.

Aqu@Fan II - Sound Data

Sizes	Speeds	AWC/AHC			AWN/AHN		
		Lw global (dBA)	Lp global (dBA)	NR	Lw global (dBA)	Lp* global (dBA)	NR*
1020	V1	-	-	-	48	27	22
	V2	-	-	-	45	24	20
	V3	-	-	-	41	20	<15
	V4	-	-	-	37	16	<15
	V5	-	-	-	32	<15	<15
2020	V1	53	45	41	53	32	28
	V2	49	41	37	49	28	24
	V3	42	34	29	44	23	18
	V4	35	27	23	35	15	<15
	V5	33	25	20	33	<15	<15
3020	V1	56	48	44	56	35	31
	V2	52	44	40	52	31	27
	V3	48	40	35	48	27	22
	V4	44	36	30	44	23	17
	V5	37	29	23	37	16	<15
4020	V1	51	43	38	51	30	25
	V2	47	39	35	47	26	22
	V3	41	33	28	41	20	15
	V4	39	31	26	39	18	<15
	V5	36	28	23	36	15	<15
5020	V1	55	47	43	55	34	30
	V2	48	40	37	48	27	24
	V3	44	36	32	44	23	19
	V4	38	30	25	38	17	<15
	V5	36	28	22	36	15	<15
6020	V1	61	53	48	61	40	35
	V2	56	48	44	56	35	31
	V3	52	44	39	52	31	26
	V4	49	41	36	49	28	23
	V5	41	33	29	41	20	16
7020	V1	65	57	52	65	44	39
	V2	60	53	48	60	39	34
	V3	56	49	44	56	35	30
	V4	49	42	37	49	28	23
	V5	48	40	35	48	27	22
8020	V1	66	58	54	66	45	41
	V2	59	51	48	59	38	35
	V3	55	47	43	57	36	32
	V4	52	44	40	52	31	27
	V5	48	40	36	48	27	23
9020	V1	70	62	57	70	49	44
	V2	68	60	55	68	47	42
	V3	65	57	52	65	44	39
	V4	59	51	46	59	38	33
	V5	57	49	44	57	36	31

The sound pressure levels Lp are based on (NR) characteristic of a room having volume of 100 m³ with reverberation time of 0.5 seconds.

(*) Informative data, considering a sound attenuation of the room and installation of 21 dB.

Aqu@Fan II - Sound Data (continued)

Sizes	Speeds	AWC/AHC			AWN/AHN		
		Lw global (dBA)	Lp global (dBA)	NR	Lw global (dBA)	Lp* global (dBA)	NR*
1030	V1	-	-	-	48	27	22
	V2	-	-	-	45	24	20
	V3	-	-	-	41	20	15
	V4	-	-	-	37	16	<15
	V5	-	-	-	33	<15	<15
2030	V1	53	45	41	53	32	28
	V2	49	41	37	49	28	24
	V3	43	35	31	45	24	19
	V4	36	28	24	38	17	<15
	V5	34	26	22	34	<15	<15
3030	V1	56	48	44	56	35	31
	V2	52	44	40	52	31	27
	V3	48	40	36	48	27	23
	V4	45	37	33	45	24	20
	V5	37	29	24	37	16	<15
4030	V1	52	44	39	52	31	26
	V2	47	39	35	47	26	22
	V3	42	34	29	42	21	16
	V4	40	32	27	40	19	<15
	V5	37	29	24	37	16	<15
5030	V1	55	47	43	55	34	30
	V2	48	40	37	48	27	24
	V3	45	37	33	45	24	20
	V4	39	31	27	39	18	<15
	V5	37	29	23	37	16	<15
6030	V1	61	53	48	61	40	35
	V2	56	48	44	56	35	31
	V3	52	44	39	52	31	26
	V4	49	41	36	49	28	23
	V5	43	35	31	43	22	18
7030	V1	65	57	52	65	44	39
	V2	61	53	48	61	40	35
	V3	54	46	41	56	35	30
	V4	50	43	38	50	29	24
	V5	46	38	34	48	27	23
8030	V1	66	58	54	66	45	41
	V2	59	51	48	59	38	35
	V3	56	48	44	56	35	31
	V4	53	45	41	53	32	28
	V5	49	41	36	49	28	23
9030	V1	70	62	57	70	49	44
	V2	68	60	55	68	47	42
	V3	66	58	53	66	45	40
	V4	60	52	47	60	39	34
	V5	57	49	44	57	36	31

The sound pressure levels Lp are based on (NR) characteristic of a room having volume of 100 m³ with reverberation time of 0.5 seconds.

(*) Informative data, considering a sound attenuation of the room and installation of 21 dB.

Aqu@Fan II - Sound Data (continued)

Sizes	Speeds	AWC/AHC			AWN/AHN		
		Lw global (dBA)	Lp global (dBA)	NR	Lw global (dBA)	Lp* global (dBA)	NR*
1021	V1	-	-	-	48	27	22
	V2	-	-	-	45	24	20
	V3	-	-	-	41	20	15
	V4	-	-	-	37	16	<15
	V5	-	-	-	33	<15	<15
2021	V1	53	45	41	53	32	28
	V2	49	41	37	49	28	24
	V3	43	35	31	43	22	18
	V4	36	30	24	36	15	<15
	V5	34	26	22	34	<15	<15
3021	V1	56	48	44	56	35	31
	V2	52	44	40	52	31	27
	V3	48	40	36	48	27	23
	V4	45	37	33	45	24	20
	V5	37	29	25	37	16	<15
4021	V1	52	44	39	52	31	26
	V2	47	39	35	47	26	22
	V3	43	35	30	43	22	17
	V4	40	32	27	40	19	<15
	V5	37	29	24	37	16	<15
5021	V1	55	47	43	55	34	30
	V2	48	40	37	48	27	24
	V3	44	36	32	44	23	19
	V4	39	31	27	39	18	<15
	V5	37	29	23	37	16	<15
6021	V1	61	53	48	61	40	35
	V2	56	48	44	56	35	31
	V3	52	44	39	52	31	26
	V4	49	41	36	49	28	23
	V5	44	36	32	44	23	19
7021	V1	67	59	54	67	46	41
	V2	61	54	49	61	40	35
	V3	54	46	41	54	33	28
	V4	51	43	38	51	30	25
	V5	46	38	34	46	25	21
8021	V1	66	58	54	66	45	41
	V2	59	51	48	59	38	35
	V3	56	48	44	56	35	31
	V4	53	45	41	53	32	28
	V5	49	41	36	49	28	23
9021	V1	70	62	57	70	49	44
	V2	68	60	55	68	47	42
	V3	66	58	53	66	45	40
	V4	61	53	48	61	40	35
	V5	55	47	43	55	34	30

The sound pressure levels Lp are based on (NR) characteristic of a room having volume of 100 m³ with reverberation time of 0.5 seconds.

(*) Informative data, considering a sound attenuation of the room and installation of 21 dB.

Aqu@Fan II - Sound Data (continued)

Sizes	Speeds	AWC/AHC			AWN/AHN		
		Lw global (dBA)	Lp* global (dBA)	NR*	Lw global (dBA)	Lp* global (dBA)	NR*
1031	V1	-	-	-	48	27	22
	V2	-	-	-	46	25	21
	V3	-	-	-	42	21	16
	V4	-	-	-	38	17	<15
	V5	-	-	-	34	<15	<15
2031	V1	53	45	41	53	32	28
	V2	50	42	37	50	29	24
	V3	44	36	32	44	23	19
	V4	37	29	25	37	16	<15
	V5	35	27	23	35	<15	<15
3031	V1	56	48	44	56	35	31
	V2	52	44	40	52	31	27
	V3	49	41	37	49	28	24
	V4	45	37	33	45	24	20
	V5	41	33	28	41	20	<15
4031	V1	52	44	39	52	31	26
	V2	47	39	35	47	26	22
	V3	42	34	30	42	21	17
	V4	40	32	27	40	19	<15
	V5	37	29	24	37	16	<15
5031	V1	55	47	43	55	34	30
	V2	48	40	37	48	27	24
	V3	45	37	33	45	24	20
	V4	39	31	27	39	18	<15
	V5	37	29	24	37	16	<15
6031	V1	62	54	49	62	41	36
	V2	58	50	45	58	37	32
	V3	55	47	42	55	34	29
	V4	51	43	38	51	30	25
	V5	47	39	34	47	26	21
7031	V1	65	57	52	65	44	39
	V2	61	53	48	61	40	35
	V3	56	48	43	56	35	30
	V4	51	43	38	51	30	25
	V5	47	39	35	47	26	22
8031	V1	66	58	54	66	45	41
	V2	59	51	48	59	38	35
	V3	57	49	45	57	36	32
	V4	54	46	42	54	33	29
	V5	49	41	36	49	28	23
9031	V1	70	62	57	70	49	44
	V2	68	60	55	68	47	42
	V3	66	58	53	66	45	40
	V4	61	53	48	61	40	35
	V5	57	49	45	59	38	34

The sound pressure levels Lp are based on (NR) characteristic of a room having volume of 100 m³ with reverberation time of 0.5 seconds.

(*) Informative data, considering a sound attenuation of the room and installation of 21 dB.

Dimensional Data - Aqu@Fan II AWC Models

HORIZONTAL DISCHARGE GRILLE

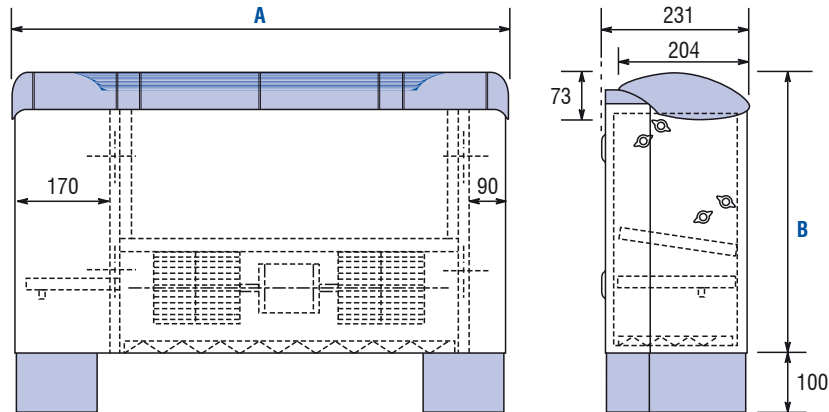

Auxiliary condensate drain pan and support feet supplied as optional

WALL MOUNTING

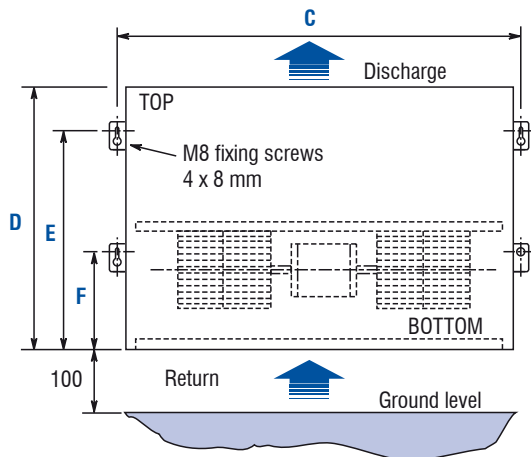

RIGHT

LEFT

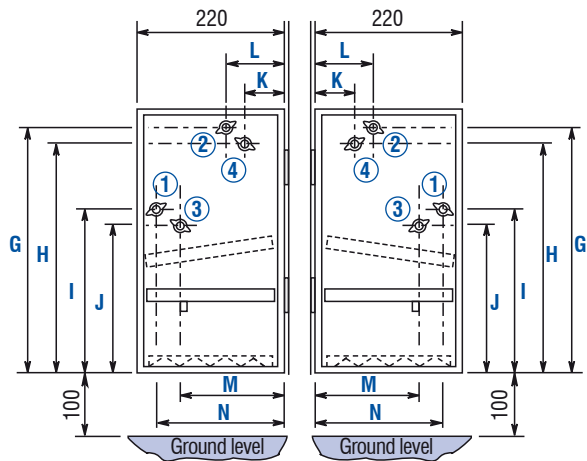

- 1 : auxiliary coil water inlet
- 2 : auxiliary coil water outlet
- 3 : main coil water inlet
- 4 : main coil water outlet

Models	A	B	C	D	E	F	G	H	I	J	K	L	M	N	Weight
20	768	478	500	430	360	150	408	390	256	236	52	95	141	183	20
30	953	478	685	430	360	150	408	390	256	236	52	95	141	183	23
40	1138	478	870	430	360	150	408	390	256	236	52	95	141	183	30
50	1323	478	1055	430	360	150	408	390	256	236	52	95	141	183	35
60	1508	478	1240	430	360	150	408	390	256	236	52	95	141	183	39
70	1323	578	1055	530	365	157	506	492	289	233	41	88	145	172	42
80	1508	578	1240	530	365	157	500	489	245	234	40	83	143	186	50
90	1693	578	1425	530	365	157	500	489	245	234	40	83	143	186	56

Dimensions are in millimeters ; weight in kilograms.

Dimensional Data - Aqu@Fan II AWN Models

FRONT VIEW - LEFT HAND CONNECTIONS

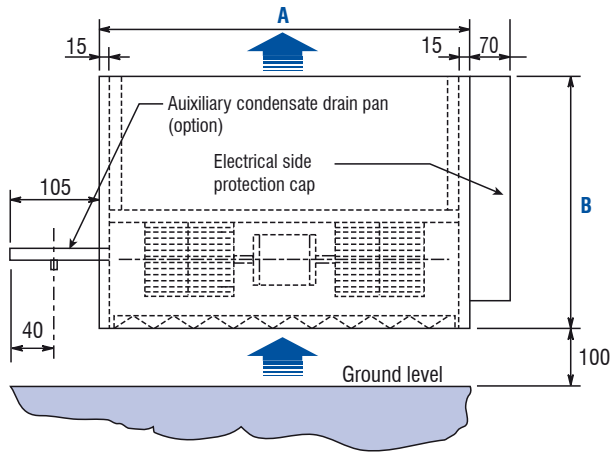

WALL MOUNTING

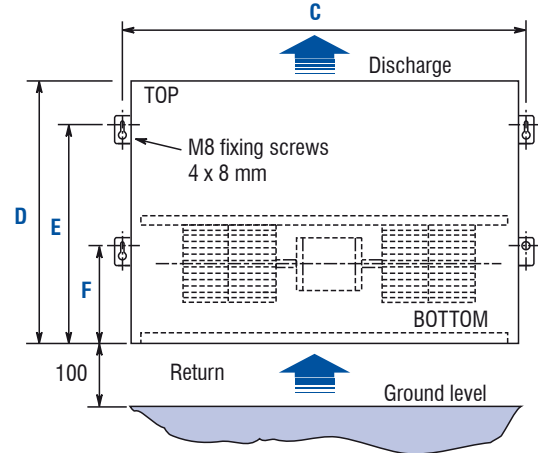

TOP VIEW - LEFT HAND CONNECTIONS

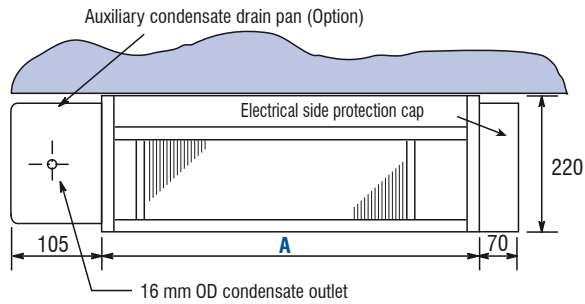

RIGHT

LEFT

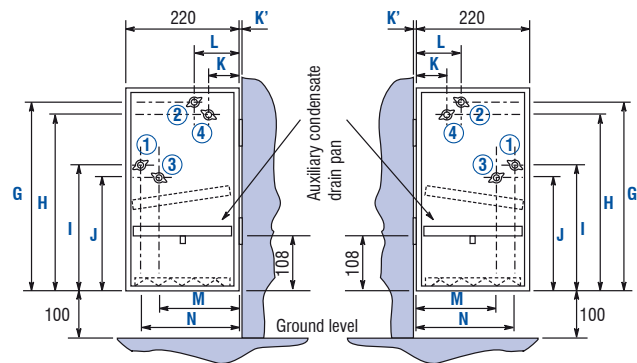

TOP VIEW - DISCHARGE DUCT CONNECTIONS

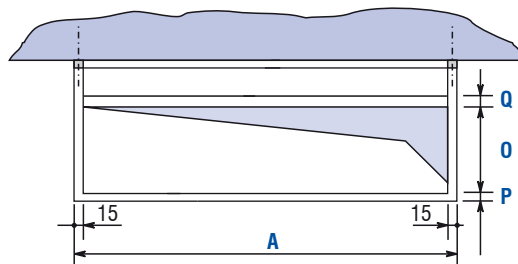

- 1 : auxiliary coil water inlet
- 2 : auxiliary coil water outlet
- 3 : main coil water inlet
- 4 : main coil water outlet

Models	A	B	C	D	E	F	G	H	I	J	K	K'	L	M	N	O	P	Q	Weight
10	370	430	360	430	360	150	406	390	255	238	54	0	95	141	182	136	20	12.2	11
20	510	430	500	430	360	150	408	390	256	236	52	3	95	141	183	130	-	11.5	14
30	695	430	685	430	360	150	408	390	256	236	52	3	95	141	183	130	-	11.5	16
40	880	430	870	430	360	150	408	390	256	236	52	3	95	141	183	130	-	11.5	23
50	1065	430	1055	430	360	150	408	390	256	236	52	3	95	141	183	130	-	11.5	27
60	1250	430	1240	430	360	150	408	390	256	236	52	3	95	141	183	130	-	11.5	30
70	1065	530	1055	530	365	157	506	492	289	233	41	3	88	145	172	130	-	12.2	34
80	1250	530	1240	530	365	157	500	489	245	234	40	0	83	143	186	136	20	12.2	41
90	1435	530	1425	530	365	157	500	489	245	234	40	0	83	143	186	136	20	12.2	46

Dimensions are in millimeters ; weight in kilograms.

Dimensional Data - Aqu@Fan II AHC Models

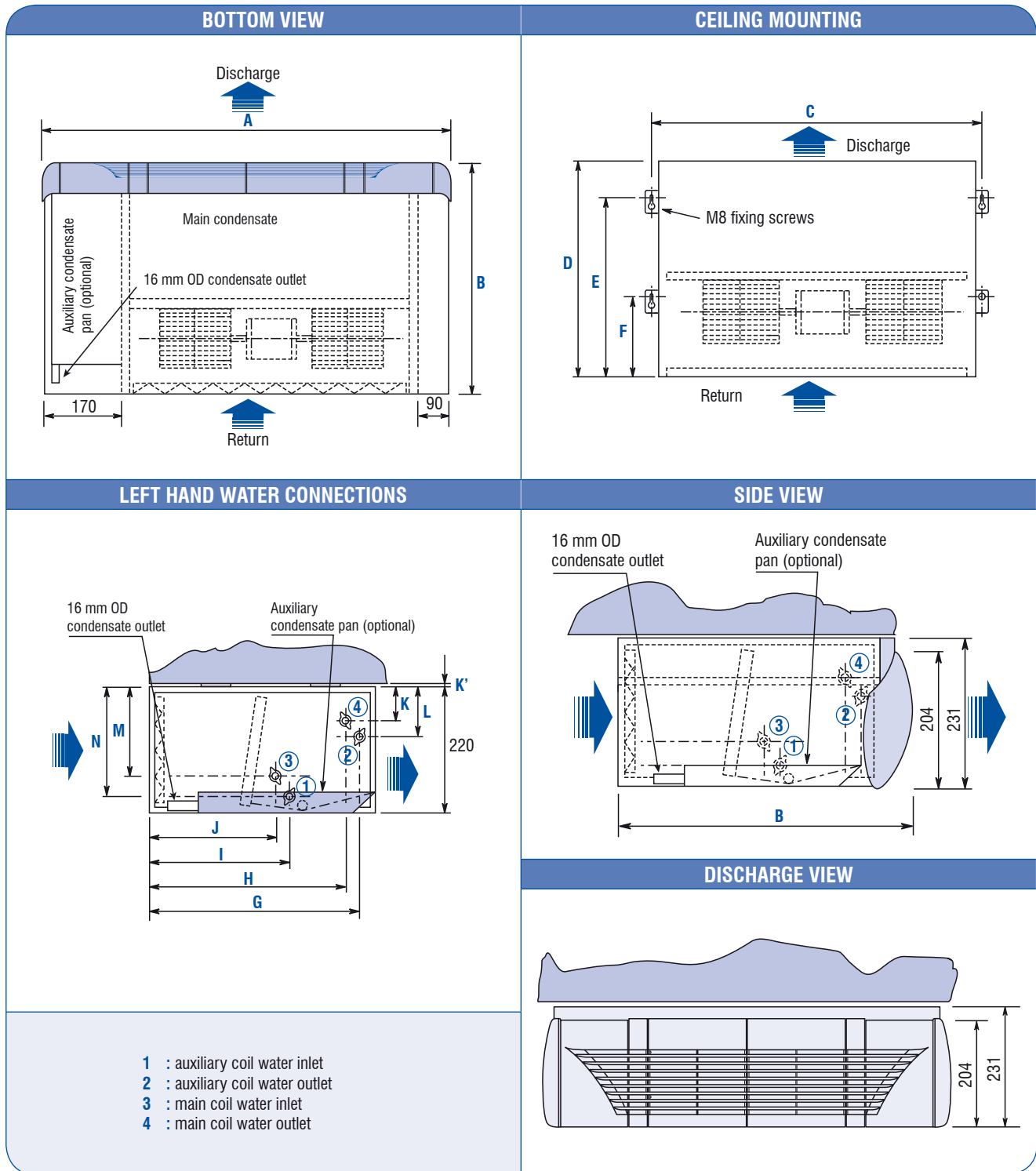

Models	A	B	C	D	E	F	G	H	I	J	K	K'	L	M	N	Weight
20	768	478	500	430	360	150	408	390	256	236	52	3	95	141	183	20
30	953	478	685	430	360	150	408	390	256	236	52	3	95	141	183	23
40	1138	478	870	430	360	150	408	390	256	236	52	3	95	141	183	30
50	1323	478	1055	430	360	150	408	390	256	236	52	3	95	141	183	35
60	1508	478	1240	430	360	150	408	390	256	236	52	3	95	141	183	39
70	1323	578	1055	530	365	157	506	492	289	233	41	3	88	145	172	42
80	1508	578	1240	530	365	157	500	489	245	234	40	0	83	143	186	50
90	1693	578	1425	530	365	157	500	489	245	234	40	0	83	143	186	56

Dimensions are in millimeters ; weight in kilograms.

Dimensional Data - Aqu@Fan II AHN Models

BOTTOM VIEW - LEFT HAND WATER CONNECTIONS

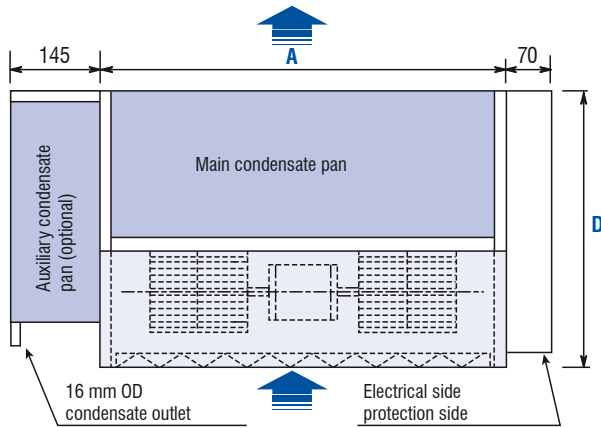

CEILING MOUNTING

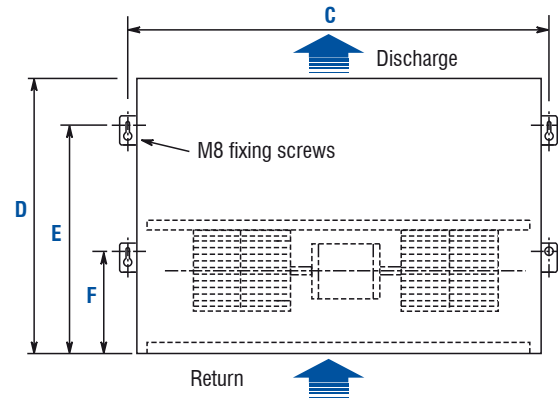

DISCHARGE VIEW

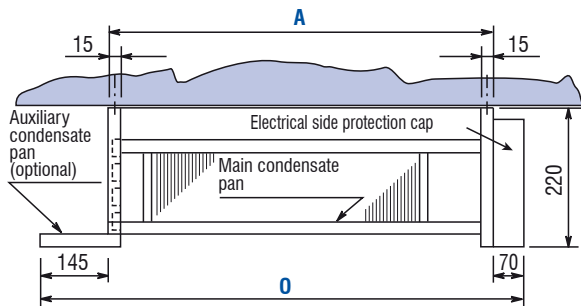

LEFT HAND WATER CONNECTIONS

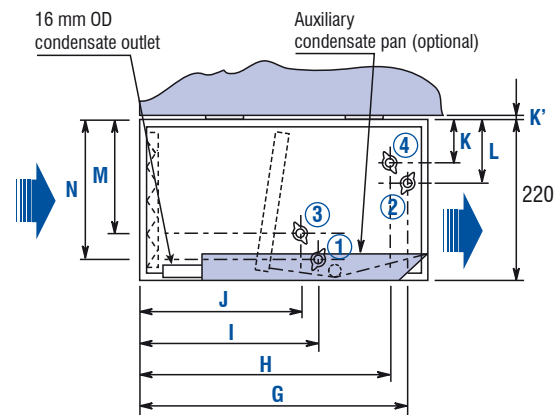

DISCHARGE DUCT CONNECTIONS

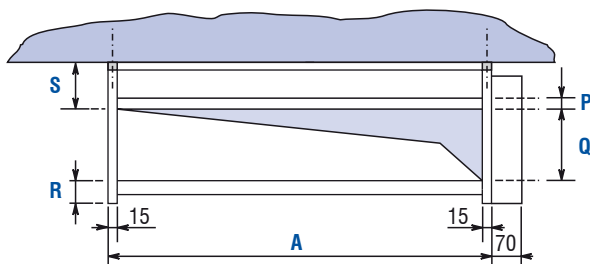

Caution ! Do not fix duct to edge of condensate drain pan, in order to allow pan removal.

- 1 : auxiliary coil water inlet
- 2 : auxiliary coil water outlet
- 3 : main coil water inlet
- 4 : main coil water outlet

Models	A	C	D	E	F	G	H	I	J	K	K'	L	M	N	O	P	Q	R	S	Weight
10	370	360	430	360	150	406	390	255	238	54	0	95	141	182	583	12.2	125	30	65	11
20	510	500	430	360	150	408	390	256	236	52	3	95	141	183	723	11.5	130	21	72	14
30	695	685	430	360	150	408	390	256	236	52	3	95	141	183	908	11.5	130	21	72	16
40	880	870	430	360	150	408	390	256	236	52	3	95	141	183	1093	11.5	130	21	72	23
50	1065	1055	430	360	150	408	390	256	236	52	3	95	141	183	1278	11.5	130	21	72	27
60	1250	1240	430	360	150	408	390	256	236	52	3	95	141	183	1463	11.5	130	21	72	30
70	1065	1055	530	365	157	506	492	289	233	41	3	88	145	172	1278	12.2	130	26	68	34
80	1250	1240	530	365	157	500	489	245	234	40	0	83	143	186	1463	12.2	125	30	65	41
90	1435	1425	530	365	157	500	489	245	234	40	0	83	143	186	1648	12.2	125	30	65	46

Dimensions are in millimeters ; weight in kilograms.