

Pompes normalisées

Description de la gamme Wilo Veronorm-NP

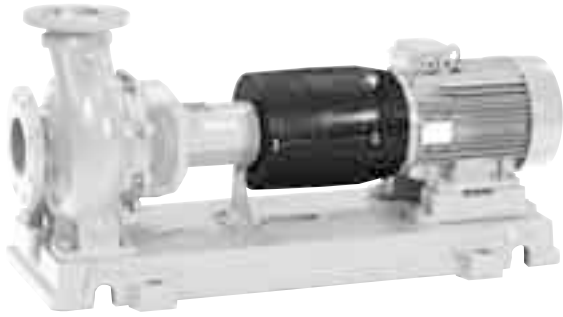

Description de la gamme Wilo VeroNorm-NP

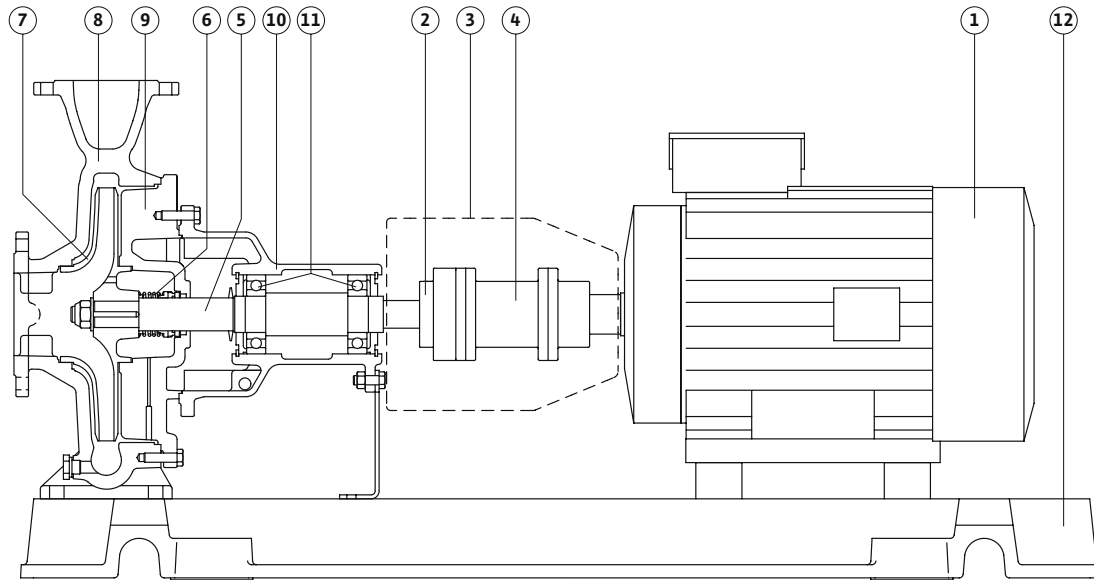

Caractéristiques techniques Wilo VeroNorm-NP

| | |
|--|--|
| | |
| | |
| | |
| | |
| | |
| | |
| | |
| | |
| | |
| | |



Pompes normalisées

Courbes caractéristiques Wilo VeroNorm-NP (2 pôles)

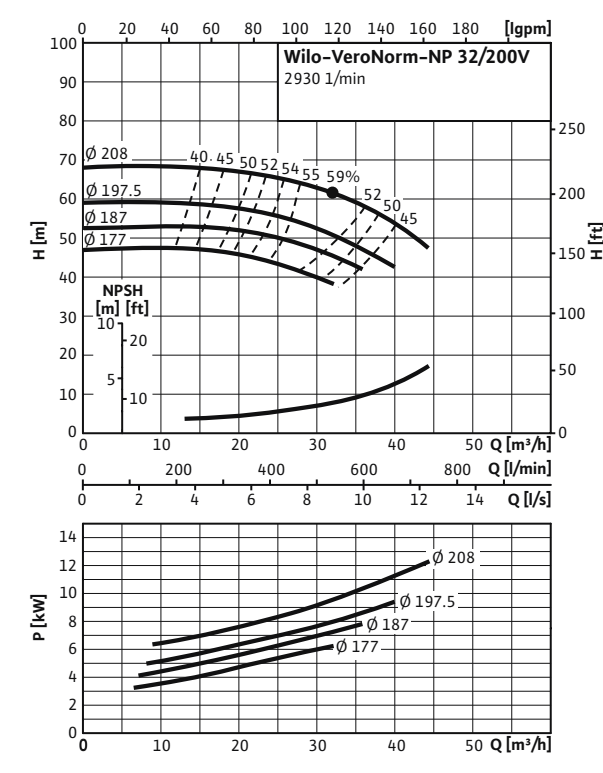
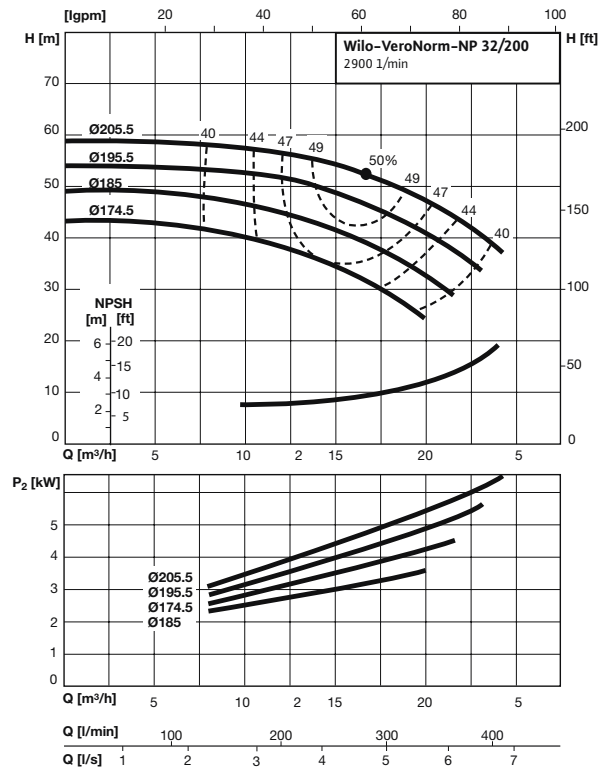
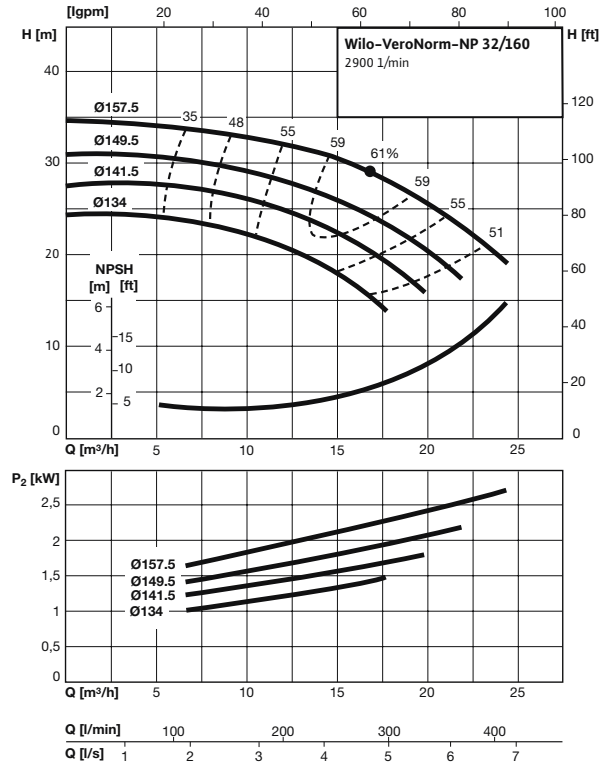
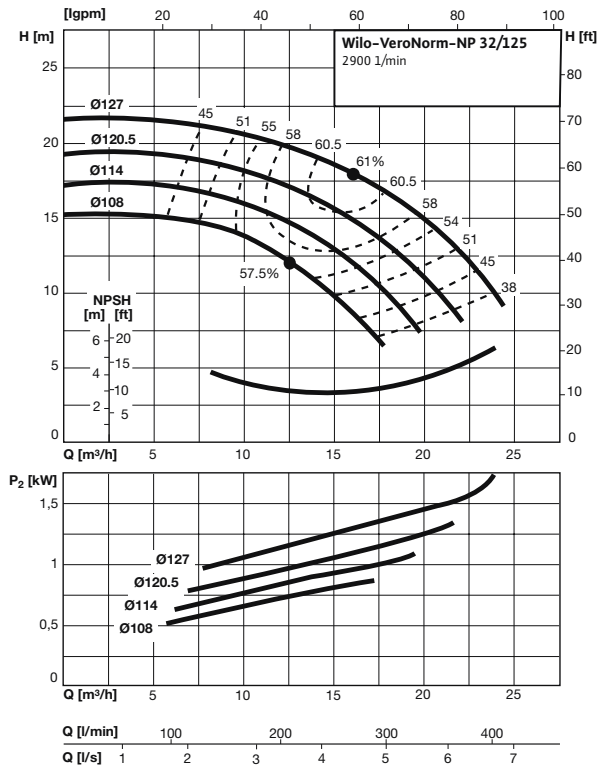

Courbes caractéristiques Wilo VeroNorm-NP (2 pôles)

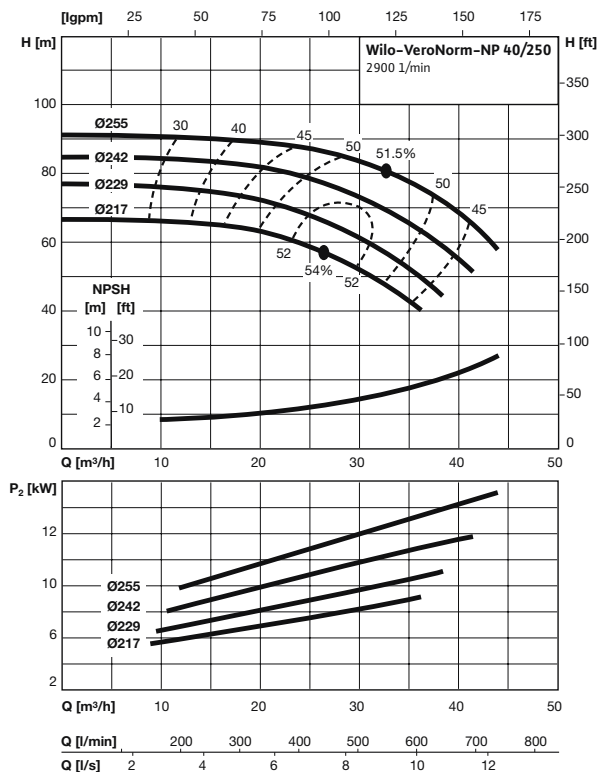
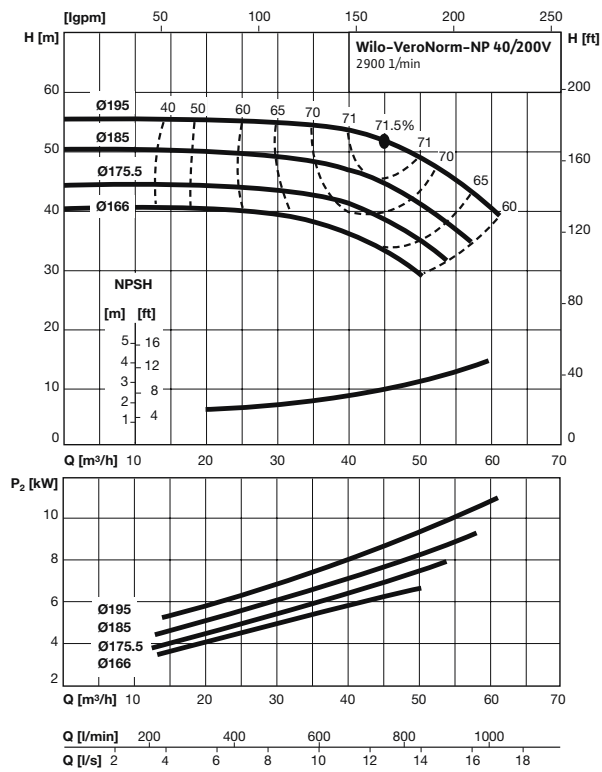
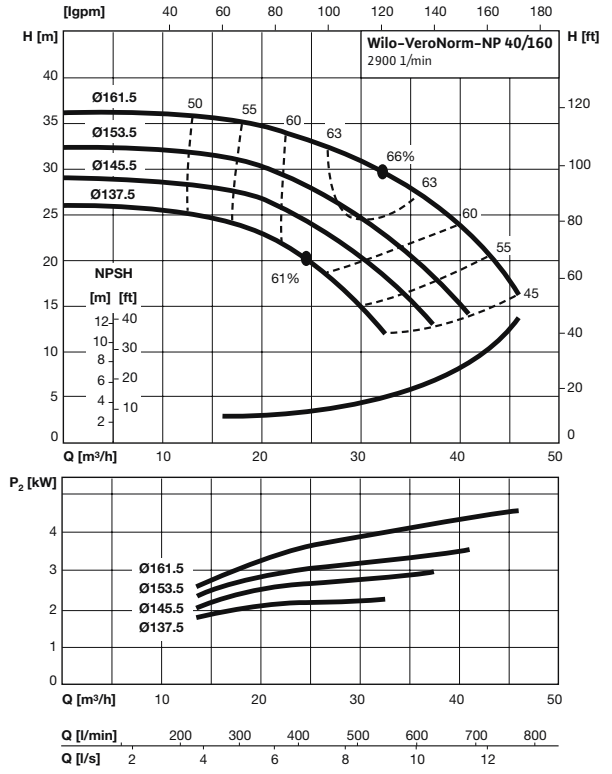
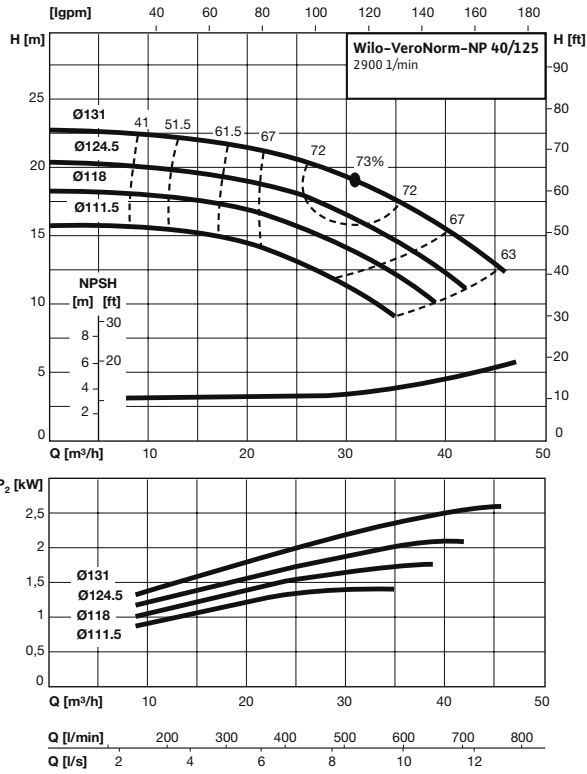

Pompes normalisées

Courbes caractéristiques Wilo Veronorm-NP (2 pôles)

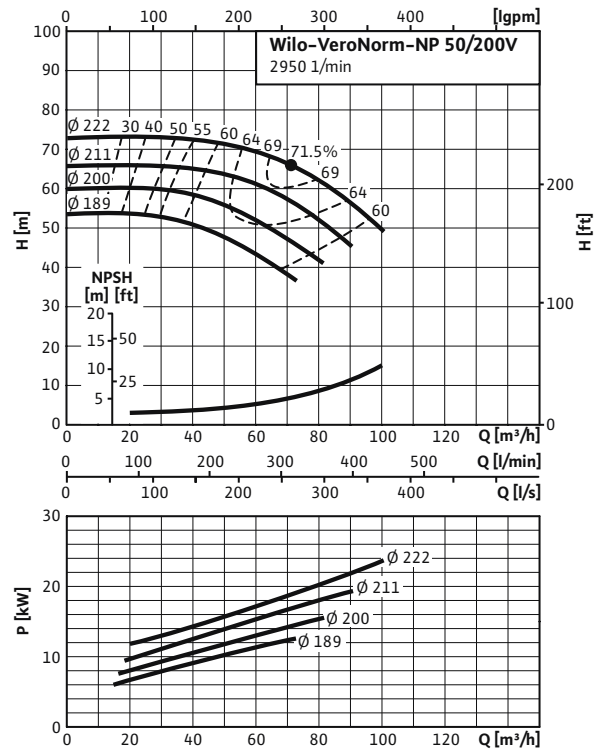
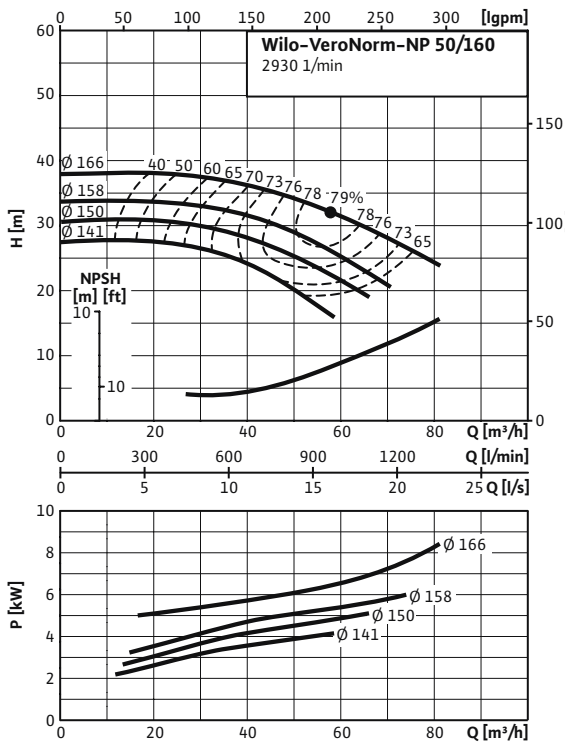
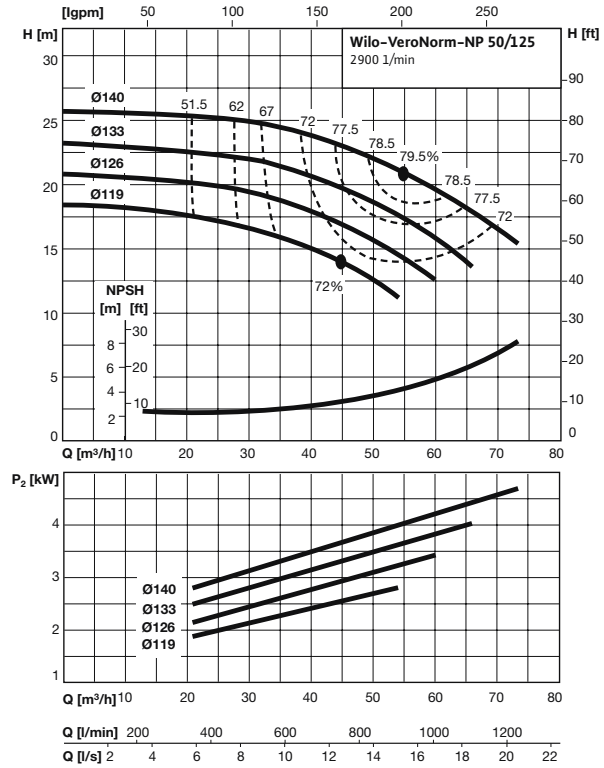
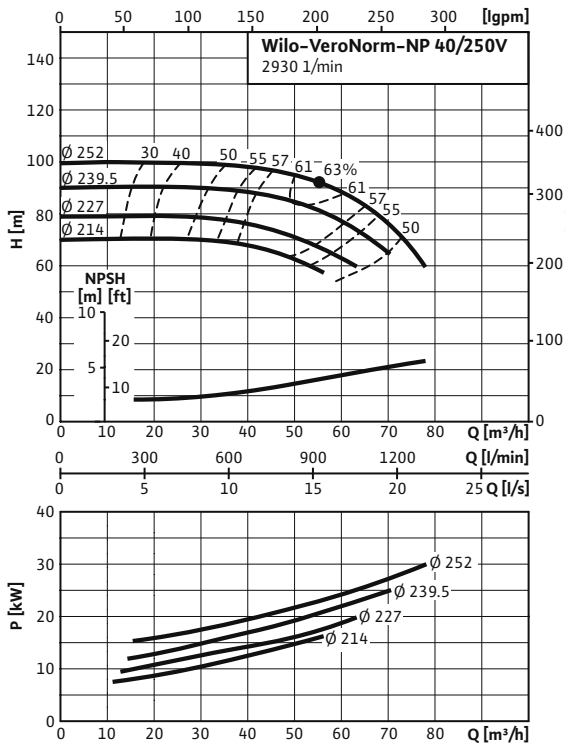

Courbes caractéristiques Wilo VeroNorm-NP (2 pôles)

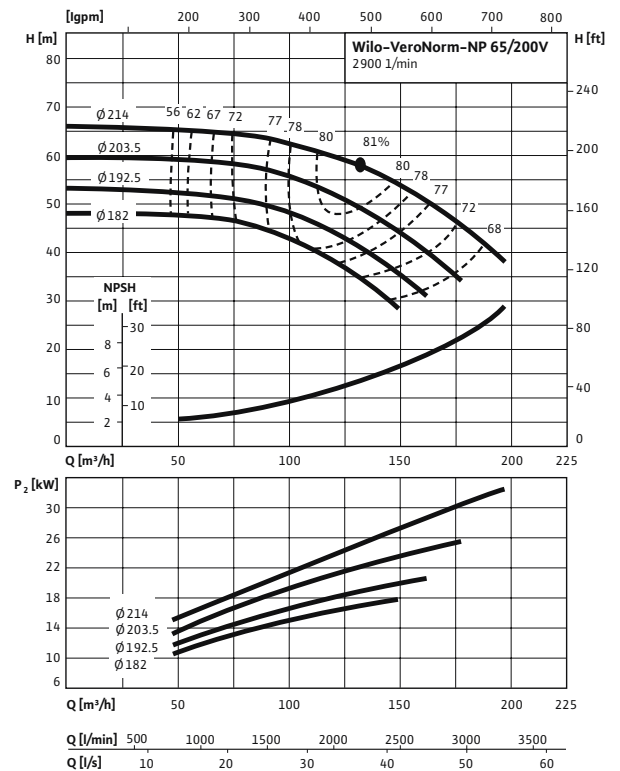
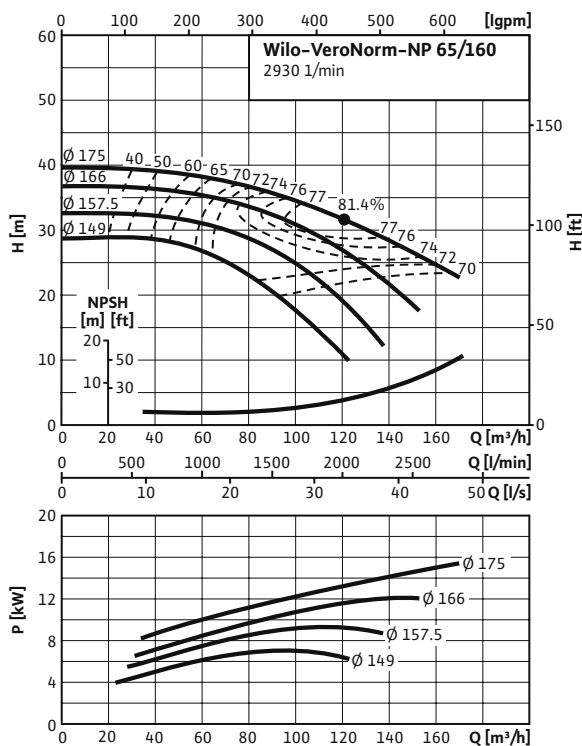
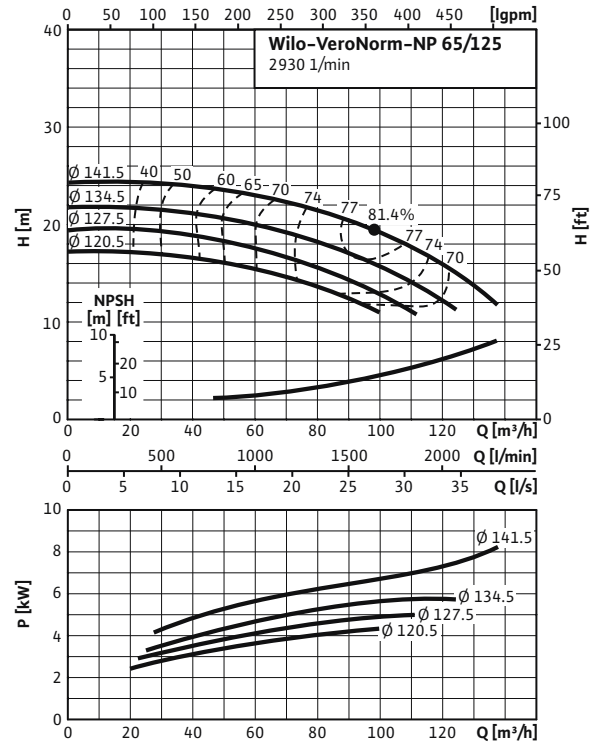
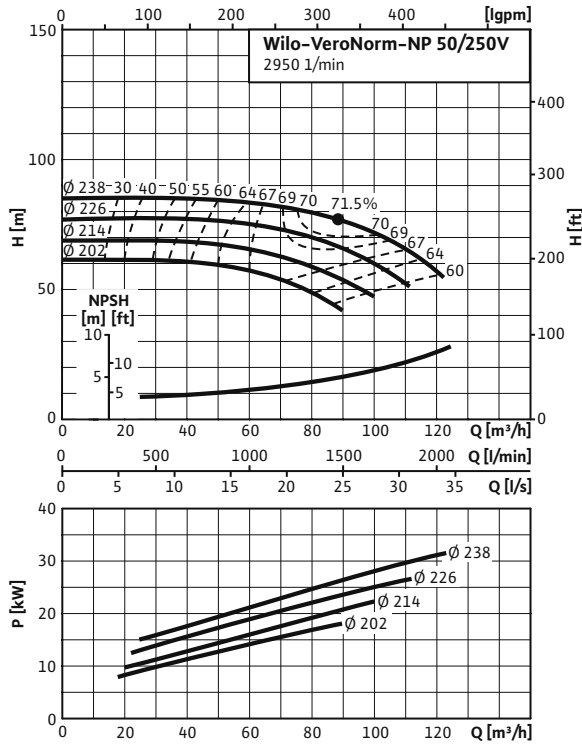

Pompes normalisées

Courbes caractéristiques Wilo VeroNorm-NP (2 pôles)

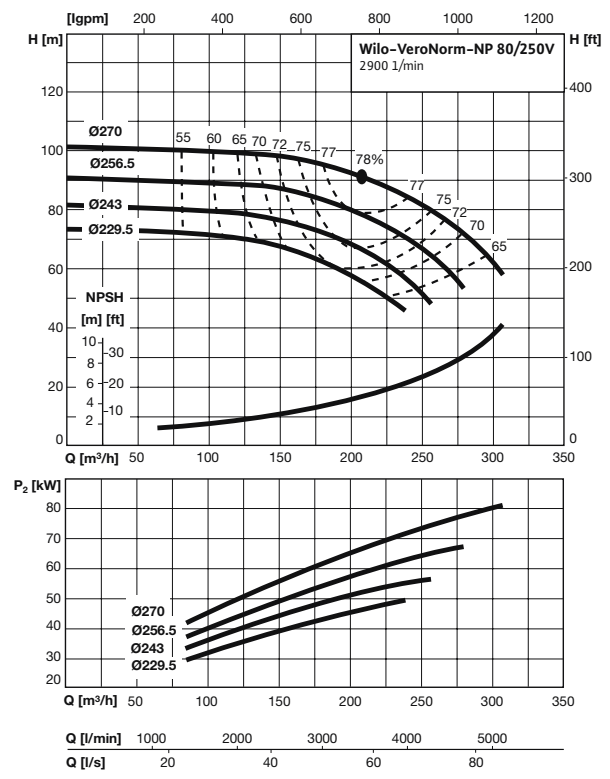
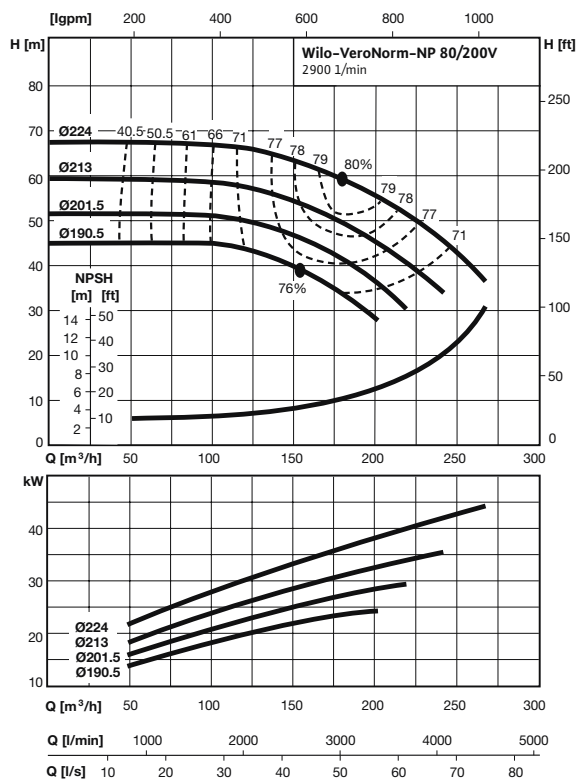
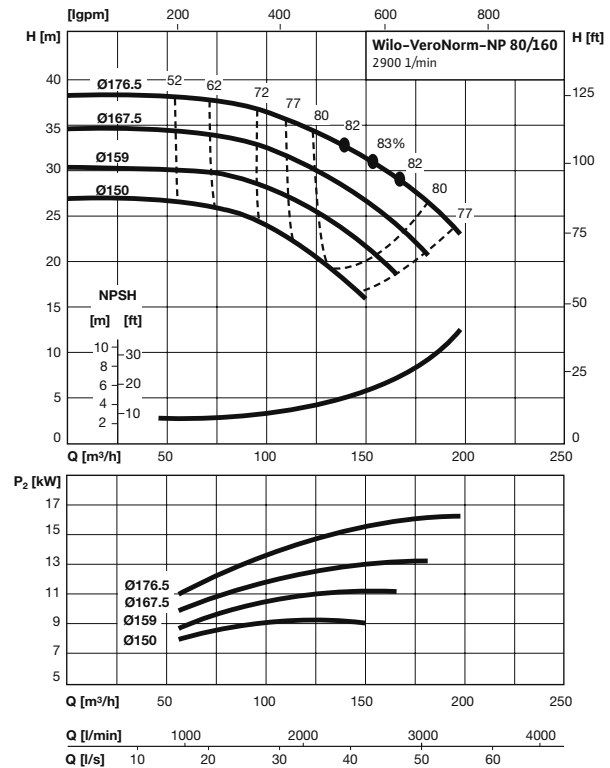
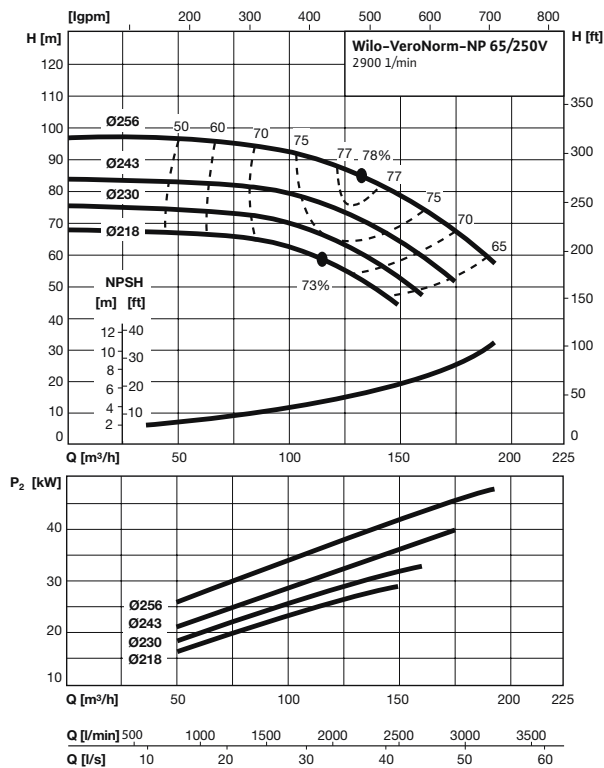

Courbes caractéristiques Wilo VeroNorm-NP (2 pôles)

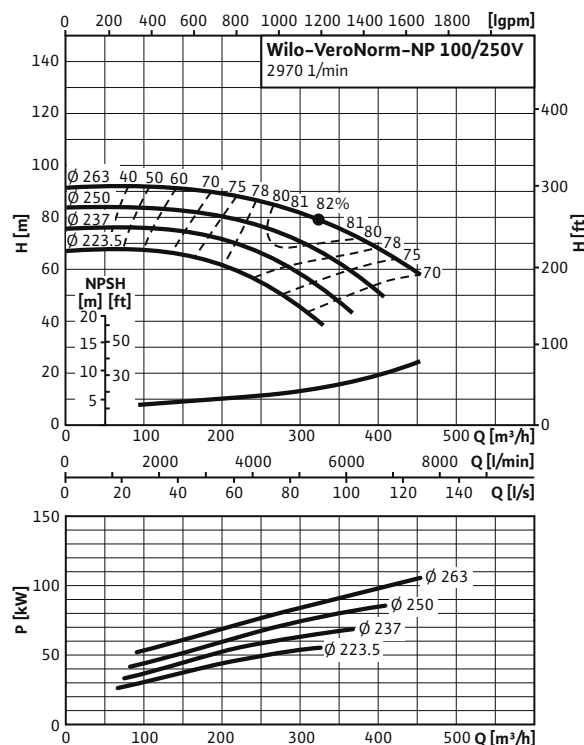
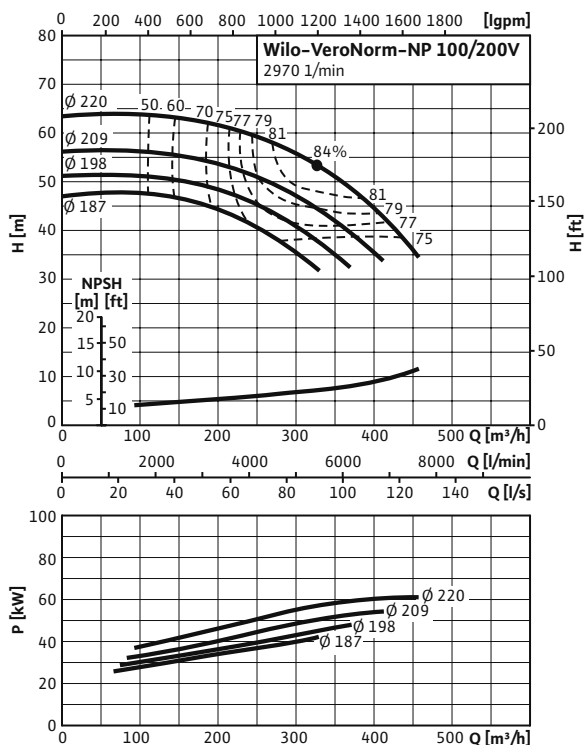

Pompes normalisées

Courbes caractéristiques Wilo VeroNorm-NP (4 pôles)

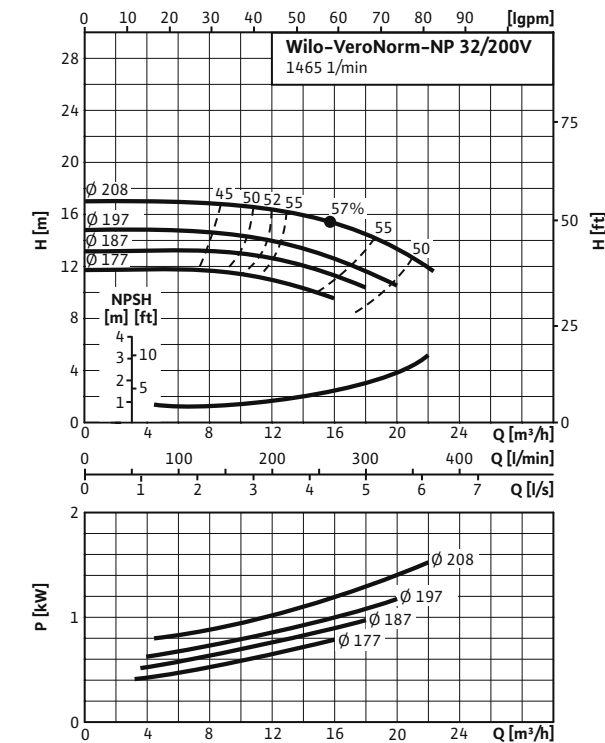
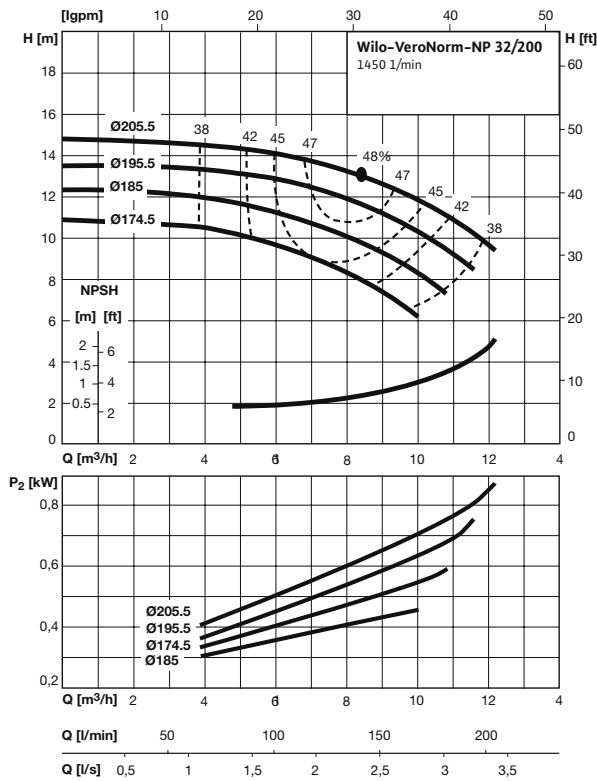
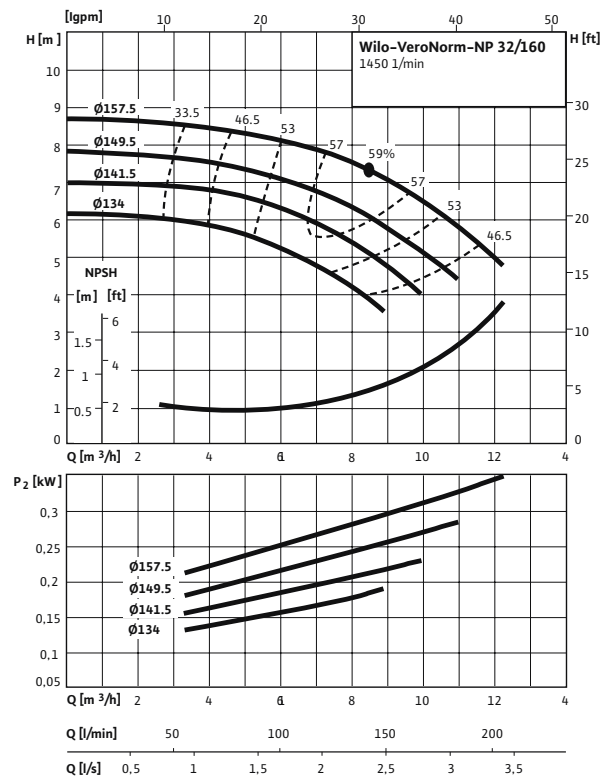
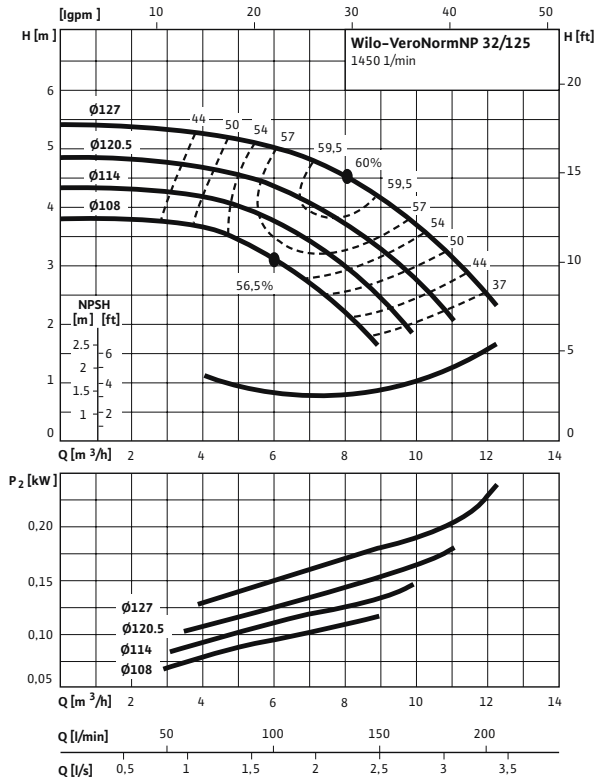

Courbes caractéristiques Wilo VeroNorm-NP (4 pôles)

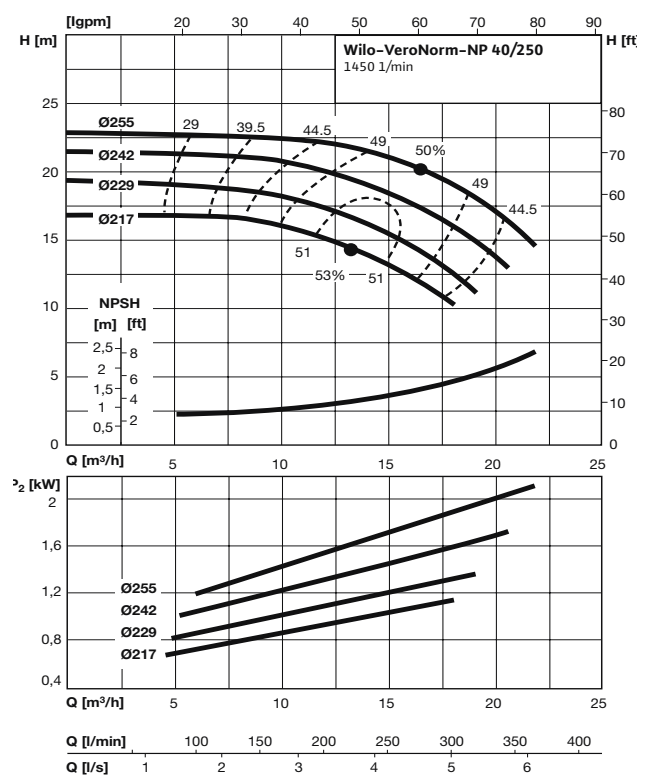
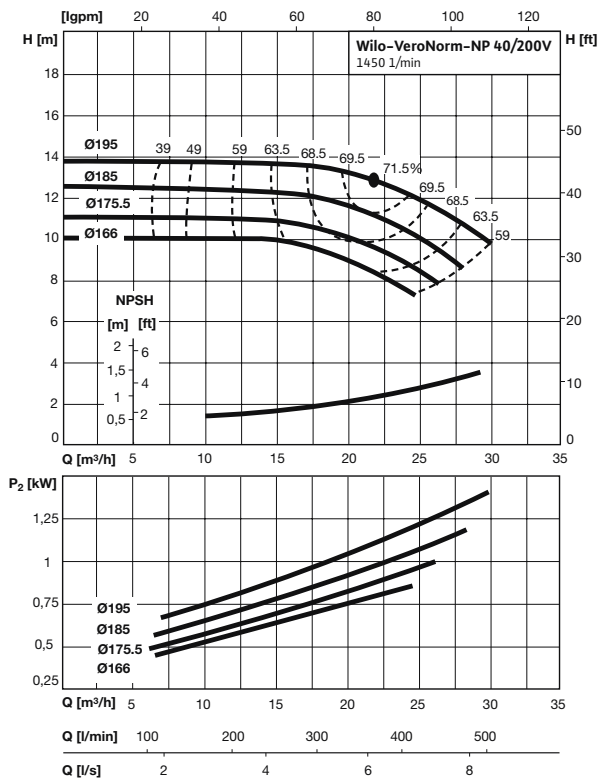
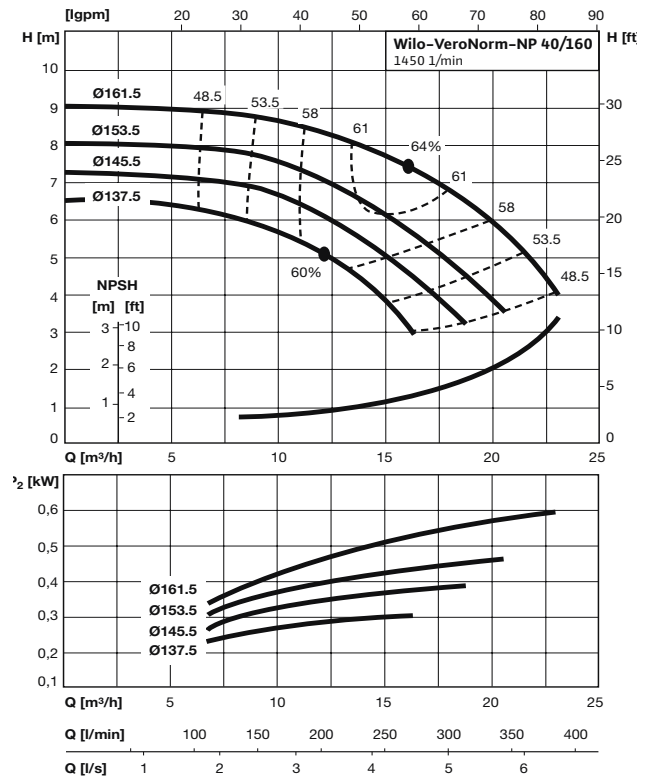
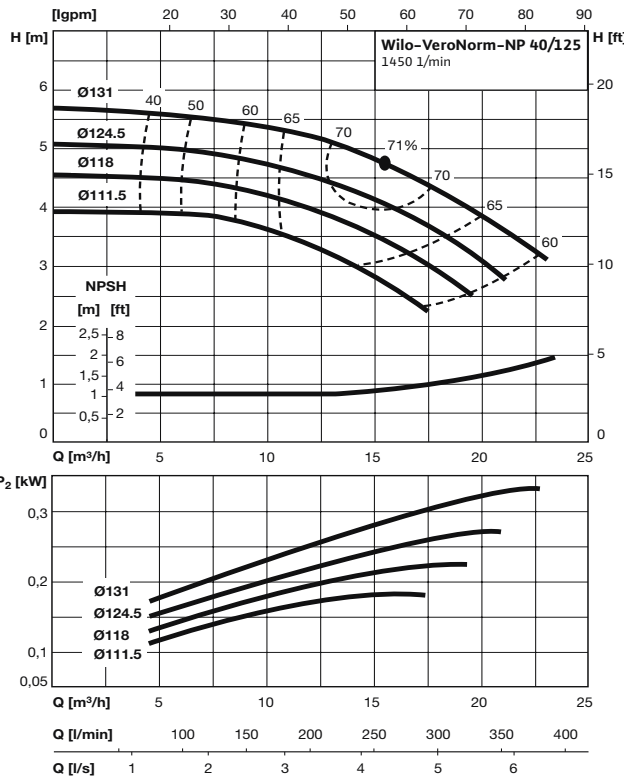

Pompes normalisées

Courbes caractéristiques Wilo VeroNorm-NP (4 pôles)

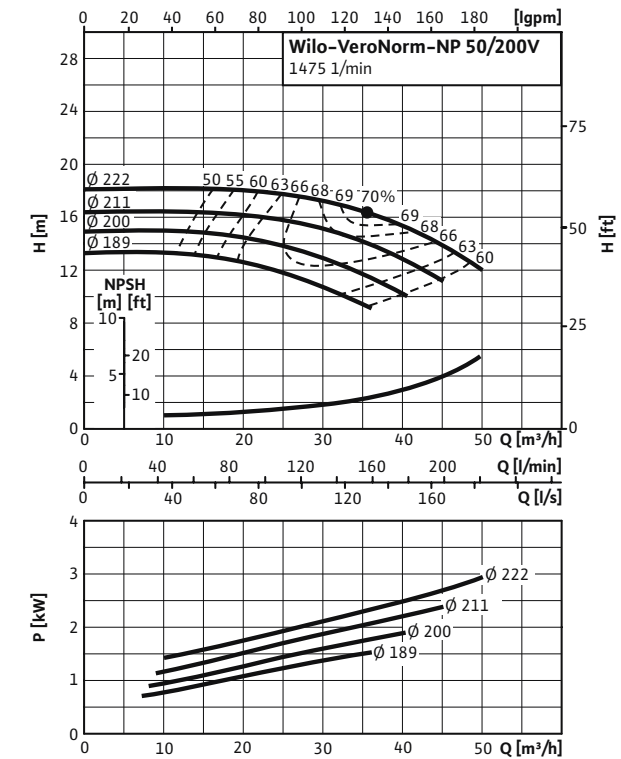
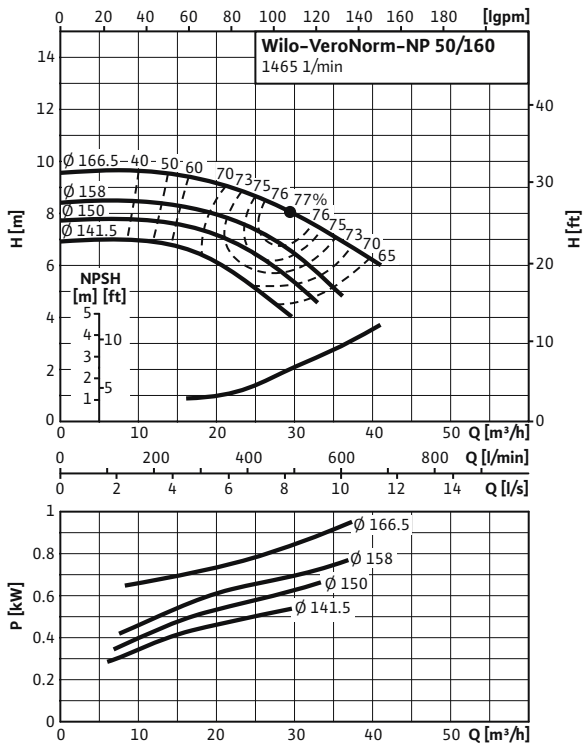
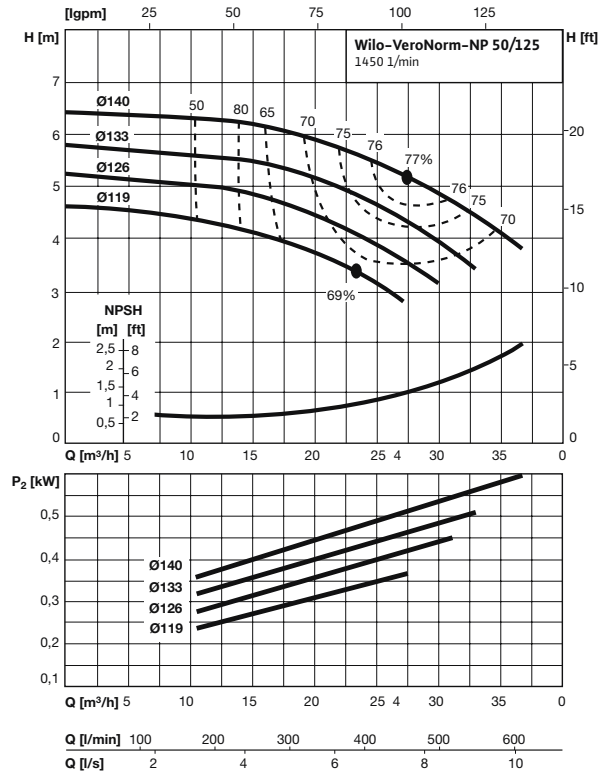
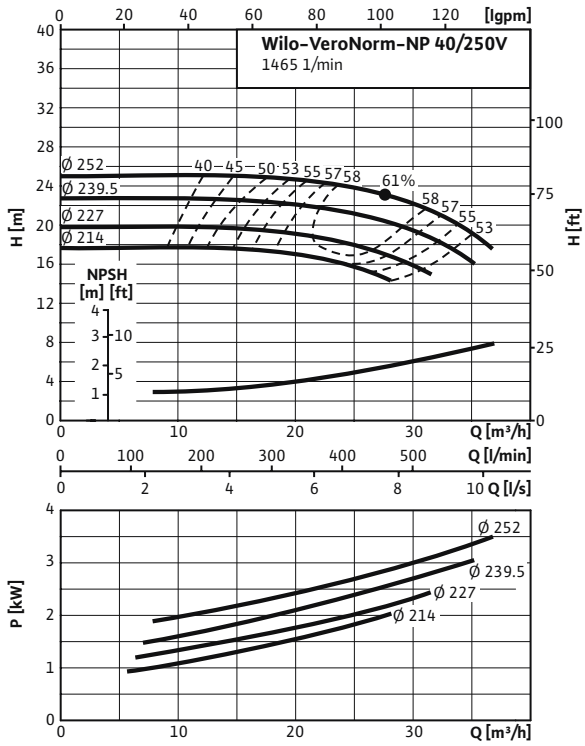

Courbes caractéristiques Wilo VeroNorm-NP (4 pôles)

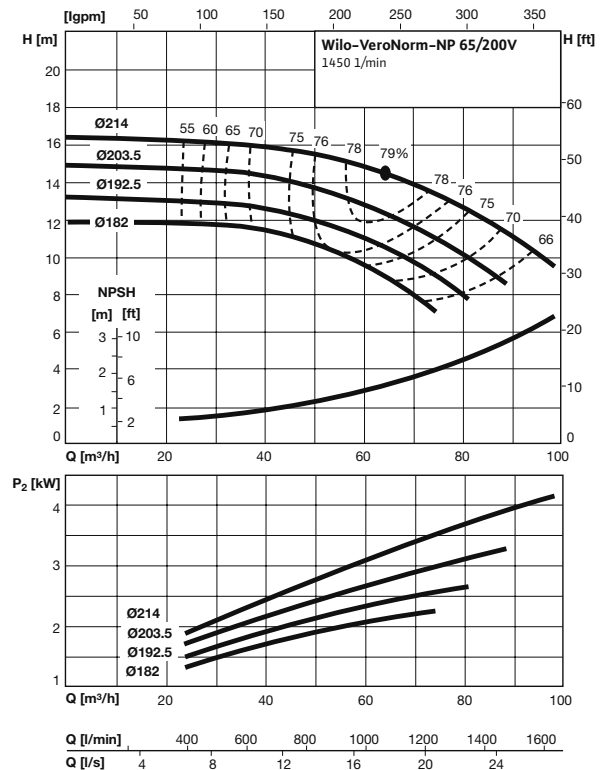
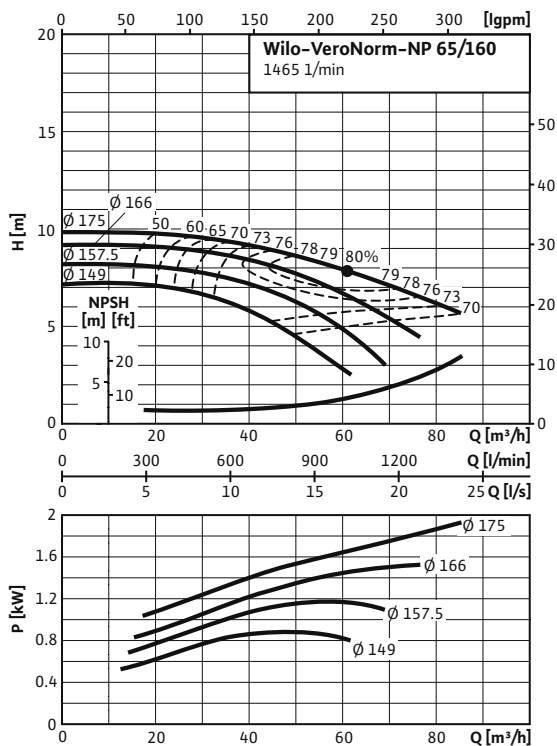
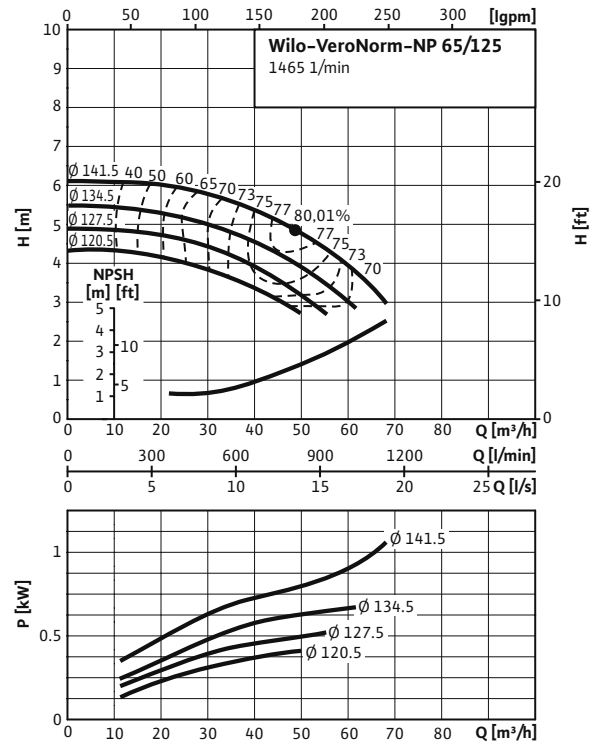
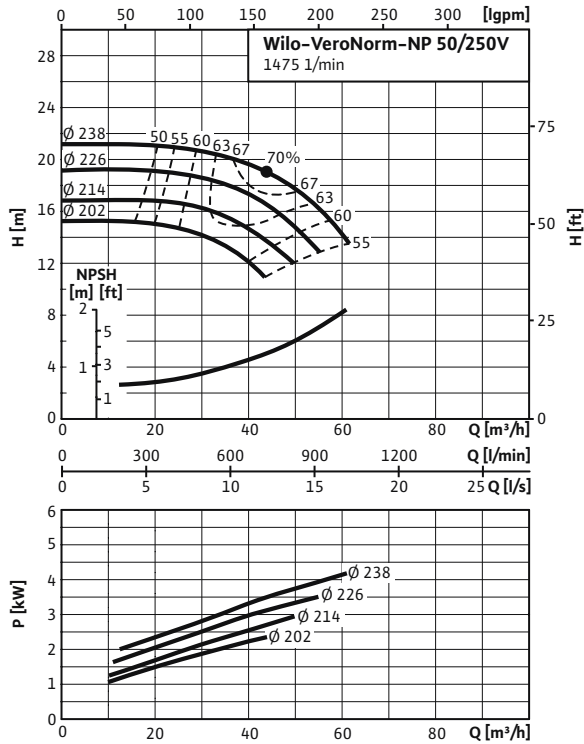

Pompes normalisées

Courbes caractéristiques Wilo VeroNorm-NP (4 pôles)

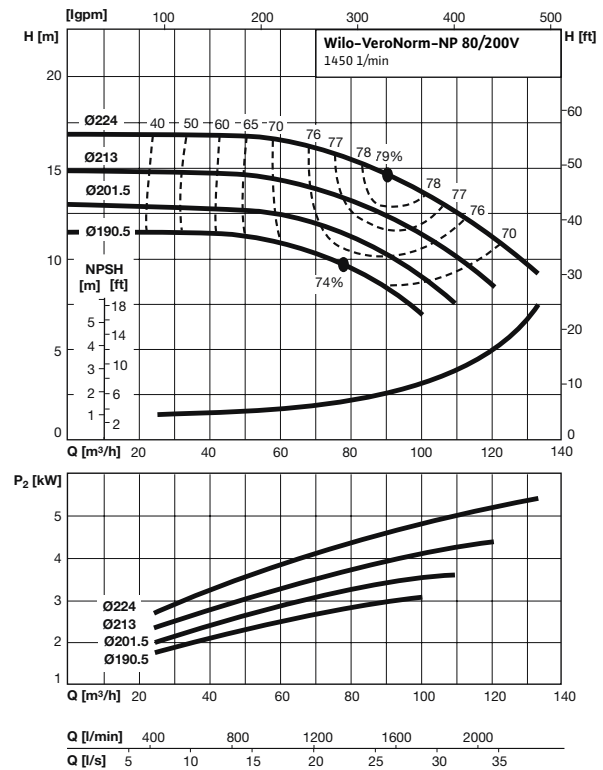
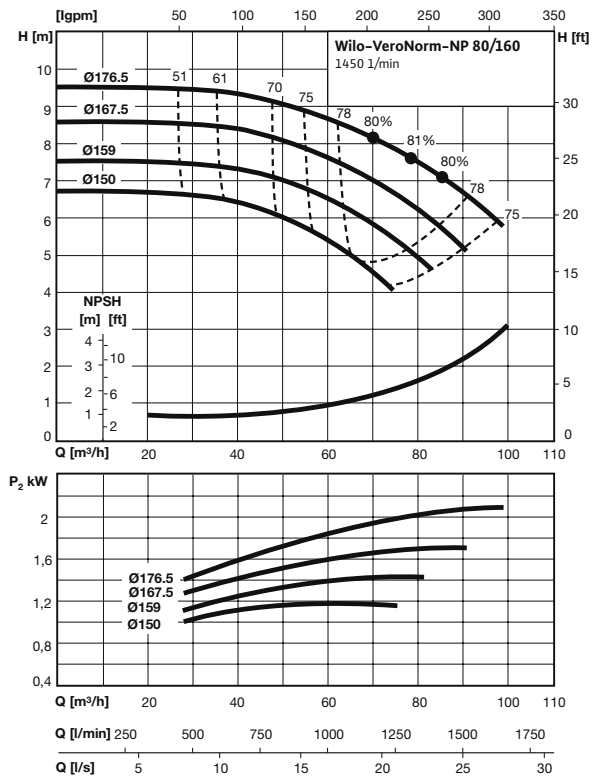
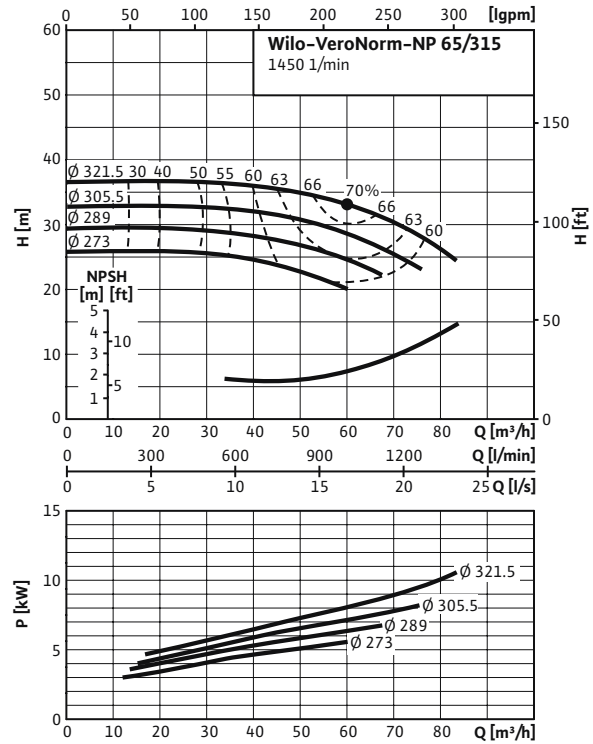
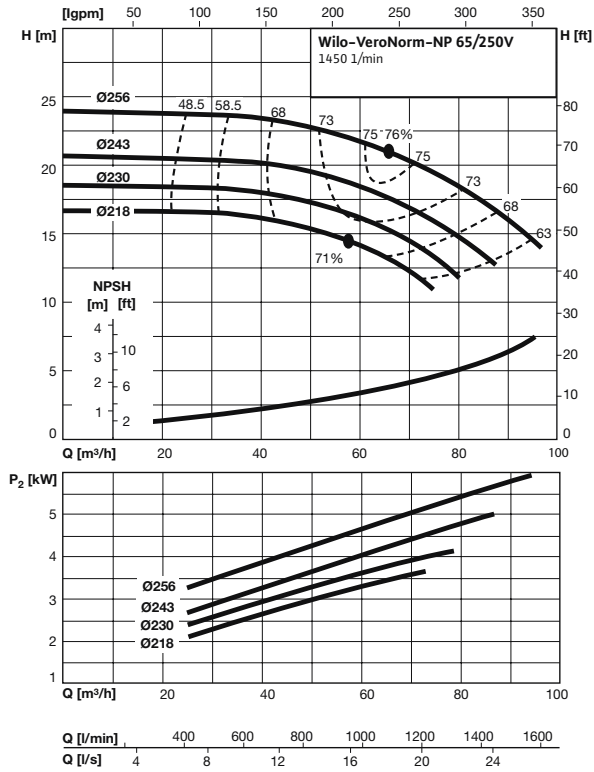

Courbes caractéristiques Wilo VeroNorm-NP (4 pôles)

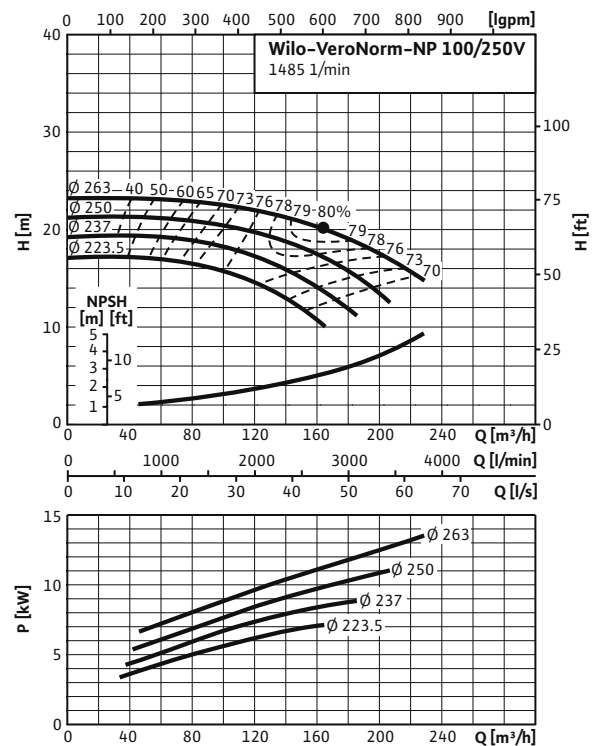
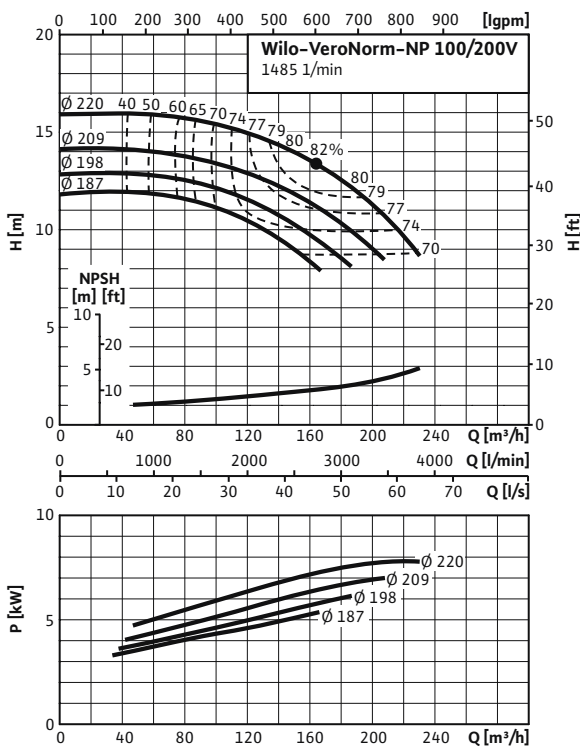
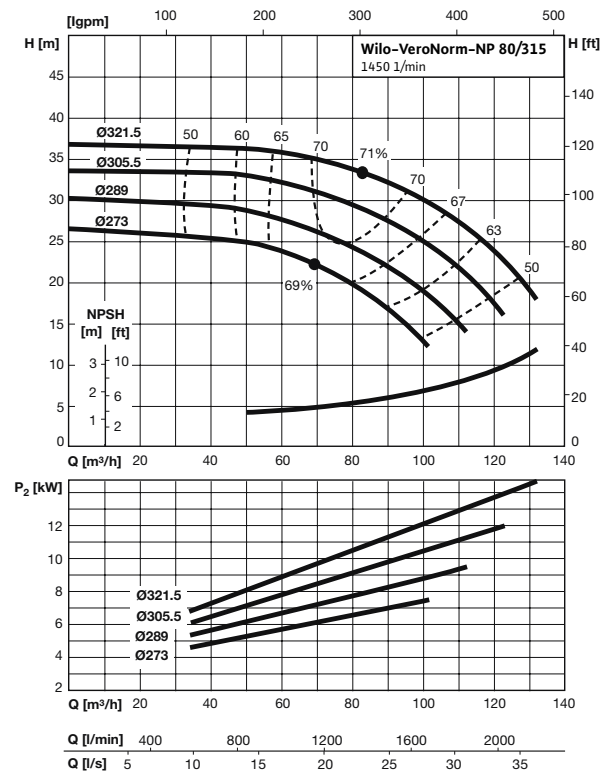
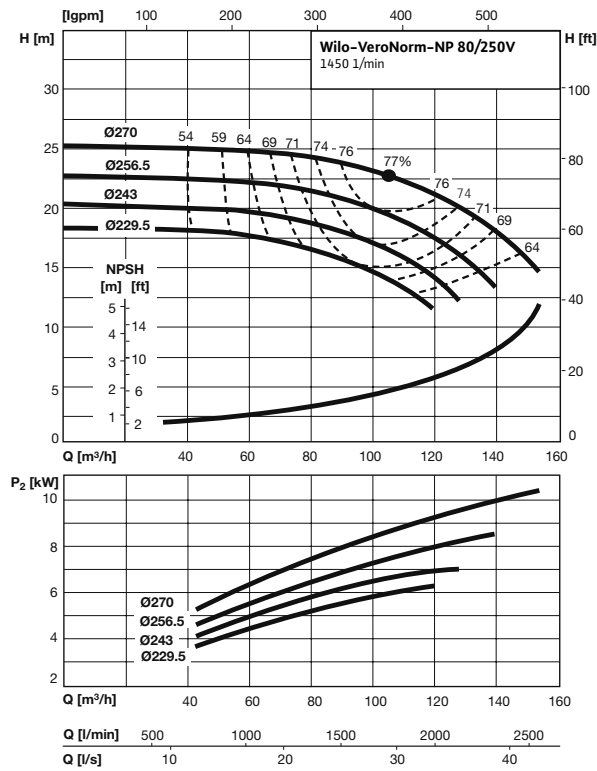

Pompes normalisées

Courbes caractéristiques Wilo VeroNorm-NP (4 pôles)

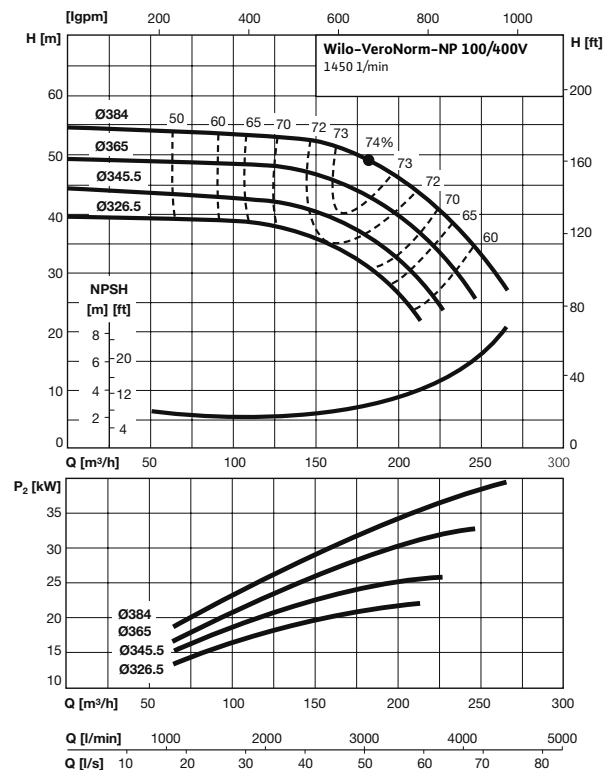
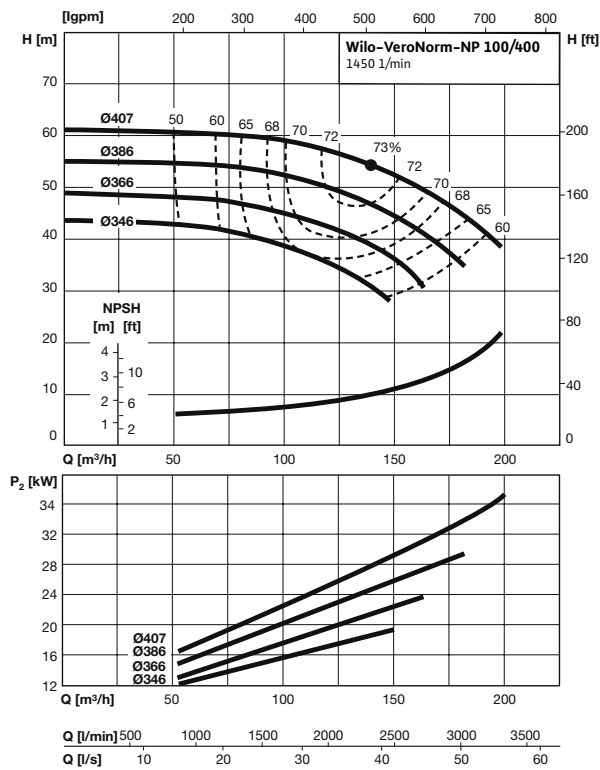
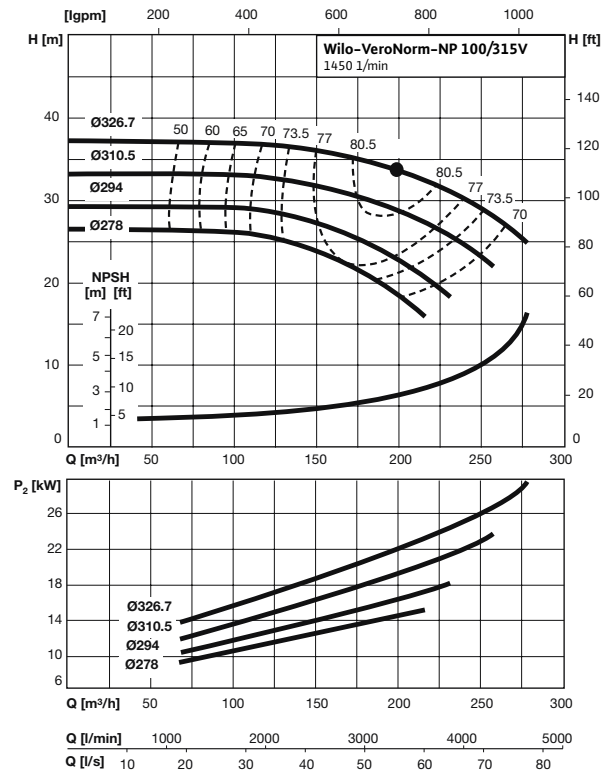
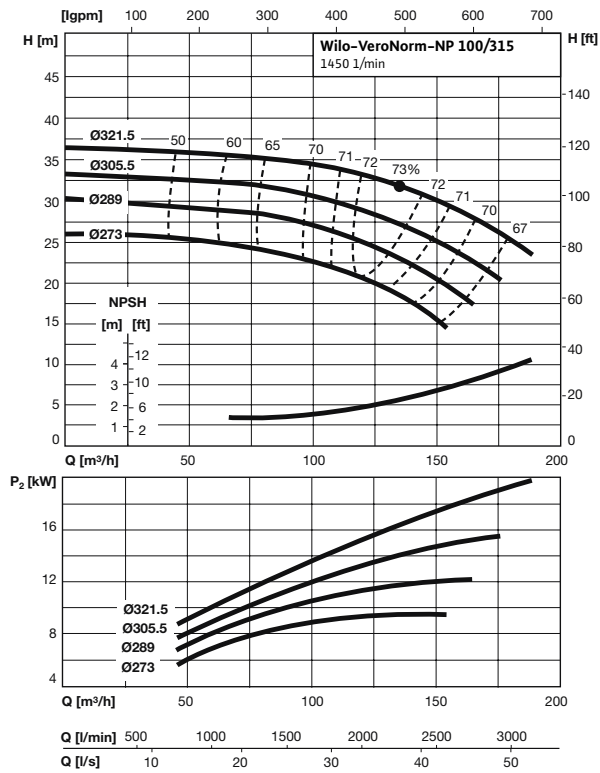

Courbes caractéristiques Wilo VeroNorm-NP (4 pôles)

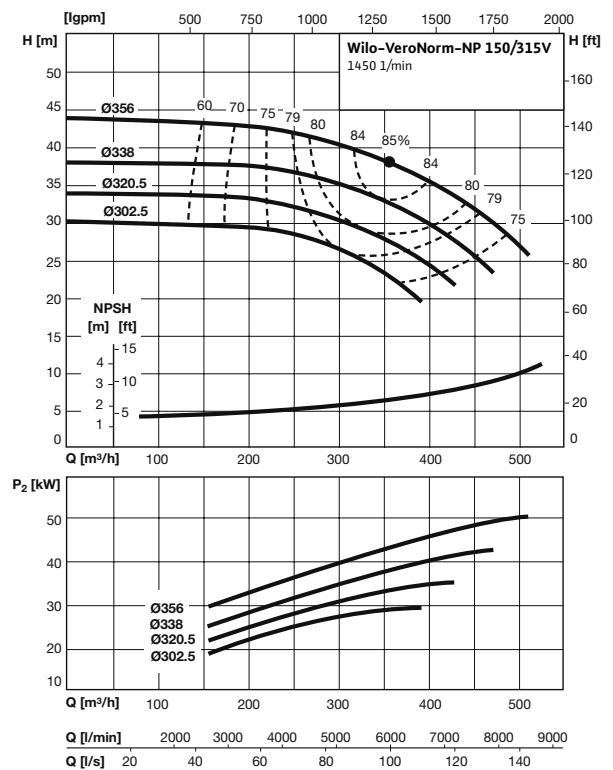
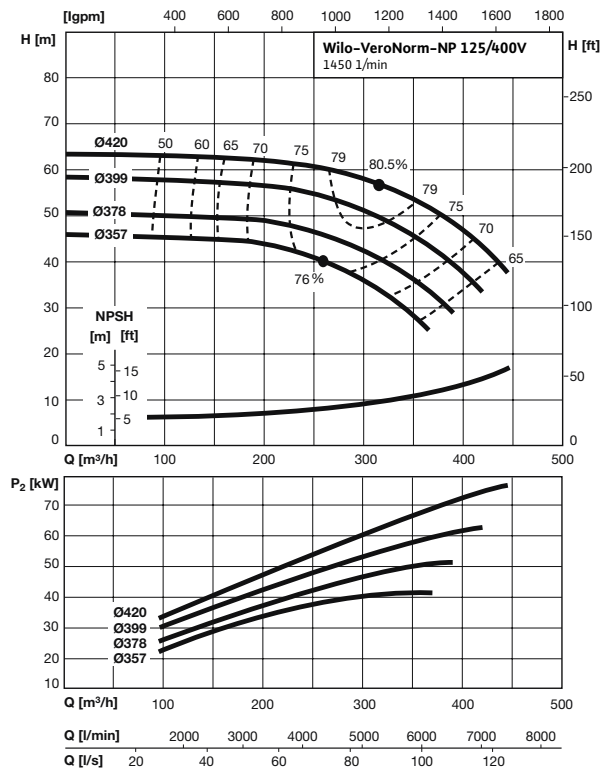
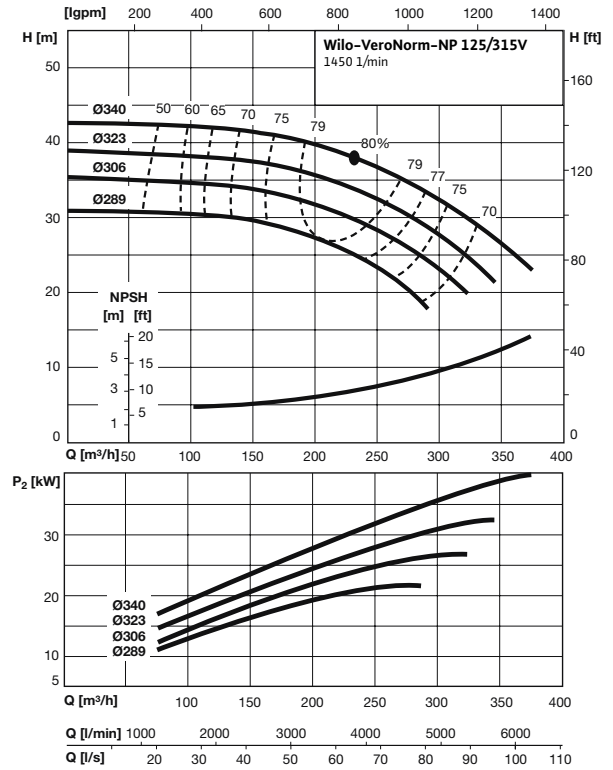
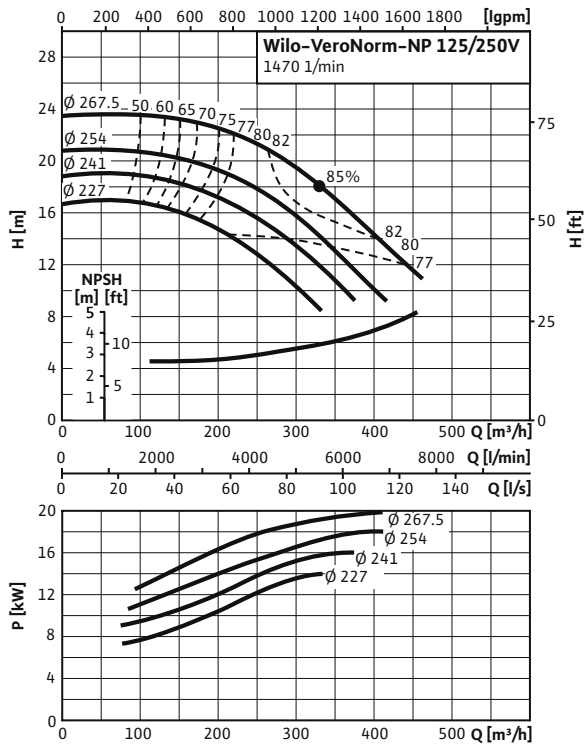

Pompes normalisées

Courbes caractéristiques Wilo VeroNorm-NP (4 pôles)

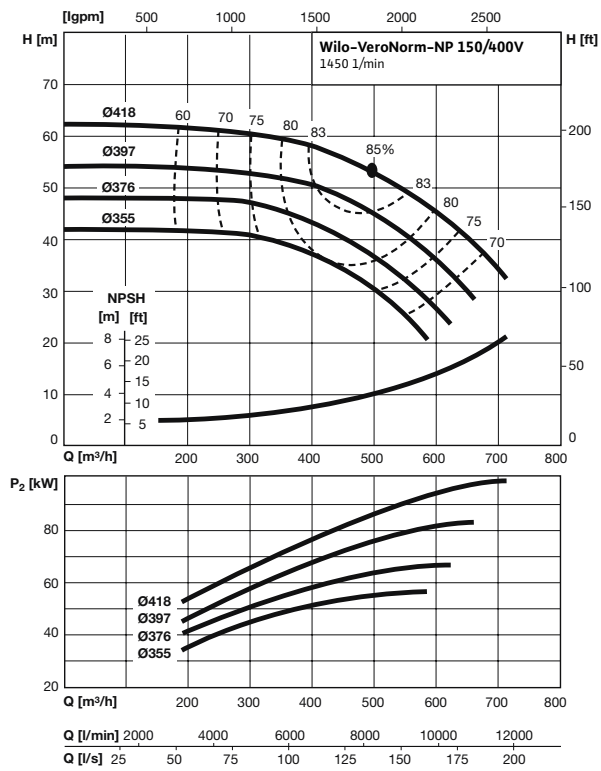

Dimensions, poids Wilo Veronorm-NP

| Type | N° | D | H | L | D ₁ | D ₂ | Dimensions | | Poids | Dimensions | | Poids | | | | |
|------|----|-----|-----|-----|----------------|----------------|------------|----|-------|------------|-----|-------|----|---|-----|-----|
| | | | | | | | mm | mm | | mm | mm | | | | | |
| A | 1 | 40 | 120 | 230 | 20 | 25 | 2 | 1 | 150 | 150 | 150 | 250 | | | | |
| | | | | | | | | | | | | | 2 | 1 | 150 | 150 |
| | | | | | | | | | | | | | 3 | 1 | 150 | 150 |
| B | 2 | 50 | 150 | 250 | 25 | 30 | 3 | 2 | 150 | 150 | 150 | 250 | | | | |
| | | | | | | | | | | | | | 4 | 2 | 150 | 150 |
| | | | | | | | | | | | | | 5 | 2 | 150 | 150 |
| C | 3 | 63 | 180 | 300 | 30 | 35 | 4 | 3 | 150 | 150 | 150 | 250 | | | | |
| | | | | | | | | | | | | | 6 | 3 | 150 | 150 |
| | | | | | | | | | | | | | 7 | 3 | 150 | 150 |
| D | 4 | 80 | 220 | 350 | 35 | 40 | 5 | 4 | 150 | 150 | 150 | 250 | | | | |
| | | | | | | | | | | | | | 8 | 4 | 150 | 150 |
| | | | | | | | | | | | | | 9 | 4 | 150 | 150 |
| E | 5 | 100 | 280 | 450 | 40 | 45 | 6 | 5 | 150 | 150 | 150 | 250 | | | | |
| | | | | | | | | | | | | | 10 | 5 | 150 | 150 |
| | | | | | | | | | | | | | 11 | 5 | 150 | 150 |

